

DATASHEET

NYX ELI 80 NUO

IR illuminator

- Infrared led illuminator high efficiency and low consumption
- IP67 weatherproof rating
- Vandal resistant IK10
- Distances: up to 180 meters (see the performance chart below)
- Integrated PSU (110Vac-230Vac) or 24Vac
- Adjustable night switch integrated
- Adjustable output power-lighting
- Infrared wavelength 850nm
- Angle of illumination: 10°, 30°, 60°, 120°



High efficiency infrared LED illuminator with integrated twilight switch

The **NYX ELI80 NUO** infrared illuminator, made of die-cast aluminium painted with polyester powder, gives an excellent protection against vandalism. Suitable for indoor/outdoor installations, it allows an appropriate lighting thank to the high efficiency LEDs with infrared emission that is not visible to the human eye. The excellent performance of the high efficiency LEDs ensures a perfect illumination of the scene, with the result of having always sharp images both with traditional Day&Night cameras and with megapixels ones.

With the integration of the adjustable twilight sensor you have the possibility to work on the on/off threshold of the illuminator, optimizing in this way the consumptions.

The innovative LED technology with optical collimator allows to obtain a high power luminous beam, as well as the advantage of reducing the consumptions and increasing the illuminator power. On issue it is supplied the clamping bracket, that allows you to mount the illuminator in a wall, on a pole (with SP/A), on a corner (with SA/A) or soldered to the housing, guaranteeing in this way a correct orientation and an excellent aesthetic result.

The **NYX ELI80 NUO** IR illuminator is particularly indicated for the perimetrical safety, urban surveillance, ports and airports installations, parking lots, sensitive areas.

DATASHEET

TECHNICAL DRAWINGS

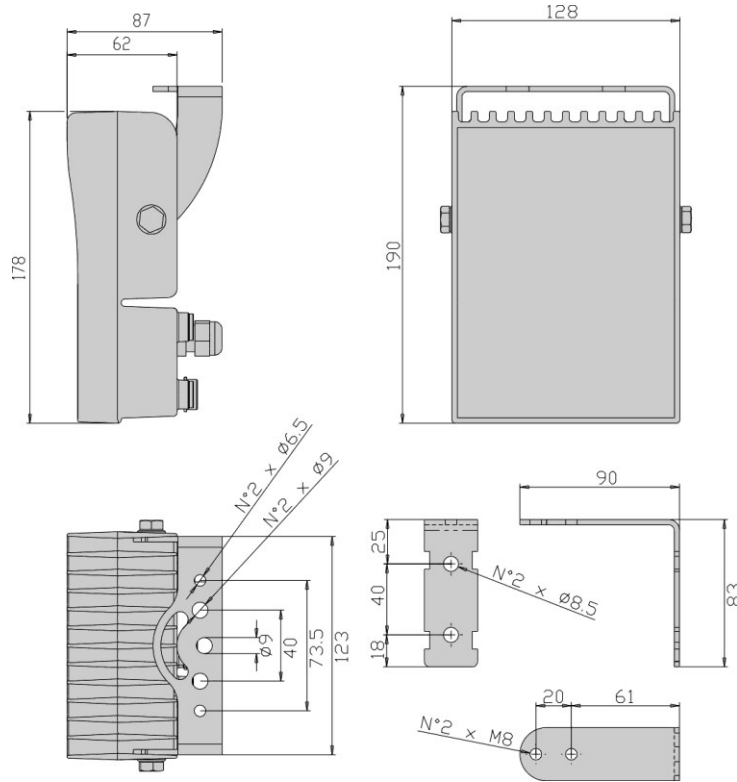

the values are in millimeters

TECHNICAL DATA

GENERAL

- die-cast aluminium construction
- stainless steel bolt and screws
- infrared wavelength 850nm
- angle of illumination: 10°-30°-60°-120°
- bracket for mounting on housing or wall (included)
- pre-wired cable 3m.
- adjustable night switch integrated
- adjustable output power-lighting
- supplied with instruction manual
- according to RoHS compliance

ELECTRICAL

- Several models:
 - Integrated power supply: 110Vac-230Vac
 - Low voltage: 24Vac-dc
- Consumption: max. 18W

MECHANICAL

- weatherproof rating IP66/67
- indoor/outdoor installations
- operating temperature from -50°C to +50°C (IR on)
- average life hours: >50.000
- dimensions (BxHxL): 128x178x62 mm.
- weight 1,6Kg.

RELATED PRODUCTS

- SP/A** pole adaptor
- SA/A** corner adaptor

DATASHEET

PERFORMANCES CHART

Model	Angle	Distance (meters) *
NYX ELI80 NUO /10	10°	180
NYX ELI80 NUO /30	30°	130
NYX ELI80 NUO /60	60°	90
NYX ELI80 NUO /120	120°	50

* typical distance in meters depends of the reflection coefficient of the illuminated scene, camera sensitivity at IR wavelength, lens combination, etc.

model	unit weight (Kg.)	package dimensions (cm.) WxHxL	package weight (Kg.)
NYX ELI80 NUO	1,60 (tot.)	21,0 x 21,0 x 14,0	2,00 (tot.)