

AMGPSU-W12-P25

LIGHT INDUSTRIAL PLUG-TOP





25W POWER SUPPLY



Light Industrial Power Solutions

AMG's light industrial plug-top / wall-wart 25W power supplies provide reliable power for AMG non-PoE based products and ensure stable equipment operation over a wide positive temperature range. They are suitable for all AMG non-PoE products (depending on voltage).



 PSU 25W 12V	 Temp 0 ~ +70°C	 Mounting Plug-Top	 Plug Head US/EU/UK	 NDAA/TAA Compliant
--	---	--	---	---

[AMGPSU-W12-P25]

/ OVERVIEW

Designed in a plug-top / wall-wart style housing, the AMGPSU-W12-P25 series of light industrial power supplies are ideally suited for powering AMG non-PoE equipment. Its wide positive operating temperature range ensures reliable operation in challenging environments.

Available in a 12V output version ensures the power supply is suitable for any low voltage non-PoE requirement.

The power supply offers a high level of stability and immunity to noise and a low ripple for best in class performance.

Compliant to the international standards for EMC and are safety approved to IEC 62368-1 Edition 2.0, UL 62368-1, CAN/CSA-C22.2 No. 62368-1-14 & EN 62368-1.

A wide voltage input range that supports 90-264V_{AC} ensures global support for all regions.

The power supply includes use changeable heads for UK, EU & USA type plugs for maximum flexibility.

/ FEATURES

- Compact size – ideal for confined spaces, including camera poles and roadside cabinets
- 0°C to +70°C temperature maintains performance in challenging environmental conditions
- Plug-Top mountable – quick to install in standard mains sockets
- High efficiency - up to 86% typical
- Universal 90-264V_{AC} input range
- Output short circuit protection included as standard
- High I/O isolation test voltage up to 4200V_{DC}
- Built-in active Power Factor Correction (PFC) function
- UK, EU & US user changeable plug heads included
- EN62368 & UL safety approved
- AMG 3 Year Support Warranty

Specifications.

Input.

Characteristics	Operating Conditions	Min.	Typ.	Max.	Unit
Input Voltage Range	AC Input	90	-	264	VAC
Input Frequency		47	-	63	Hz
Input Current	115VAC	-	0.7	-	A
	230VAC	-	0.29	-	
Inrush Current	115VAC Cold Start	40	-	50	
	230VAC Cold Start	80	-	120	
Power Factor	115VAC	-	0.3	-	-
	230VAC	-	0.3	-	
Leakage Current	264VAC	<0.25mA			
Connector		UK / EU/ USA Plug Types			

Output.

Characteristics	Operating Conditions	Min.	Typ.	Max.	Unit
Output Voltage Accuracy	Full Load Range	-	±1	-	%
Line Regulation	Rated Load	±0.5	-	±1	
Load Regulation	10% - 90% Load	±4	-	±5	
Output Ripple & Noise*	20MHz Bandwidth (peak-to-peak value)	-	-	220	mV
Stand-by Power Consump.		-	<0.1	-	W
Short Circuit Protection	Recovery time <10s after the short circuit disappears	Hiccup, Self-Recovery			
Over-Voltage Protection		Not Present			
Over-Temperature Protect		Not Present			
Minimum Load		0	-	-	%
Start-up Delay Time	230VAC	-	3	-	s
Hold-up Time	115VAC	-	12	-	ms
Connector		None - Stripped & Tinned Cable			
Note: *The "tip and barrel method" is used for ripple and noise test, output parallel 47µF electrolytic capacitor and 0.1µF ceramic capacitor.					

Specifications.

General.

Characteristics	Operating Conditions	Min.	Typ.	Max.	Unit
Dielectric Withstanding Voltage (P-S)	Primary to Secondary	-	-	4242	VDC
Electro Static Discharge	Air Discharge - IEC61000-4-2	-	-	8	kV
	Contact Discharge - IEC61000-4-2	-	-	4	
Surge Voltage	Line-Neutral	-	-	1	kV
	Line-PE & Neutral-PE	-	-	2	
Operating Temperature	See De-Rating Chart	0	-	+70	°C
Storage Temperature		-40	-	+85	
Operating Humidity	Non-Condensing	0	-	95	%RH
Storage Humidity	Non-Condensing	10	-	95	
Operating Altitude	All Conditions	-	-	2000	m
Vibration	10~500Hz, 10min/1cycle, 60min X/Y/Z	-	5	-	G
Operating Temperature Power Derating	+40°C to +70°C	1.66	-	-	%/°C
Input Voltage Derating		N/A			
Safety Standard		IEC/EN/UL62368 C.S.A C22.2			
Safety Class		Class II			
MTBF	MIL-HDBK-217F @ 25°C	>100,000 hours			

Mechanical.

Case Material	Plastic
Dimensions	85 × 43 × 48 mm (3.35 × 1.69 × 1.89 in) (H x W x D)
Weight	0.16 kg (0.35 lb)
Cooling	Free Air Convection

Regulatory.

Emissions	CE	CISPR32/EN55032 Class B
	RE	CISPR32/EN55032 Class B
	FCC	Part 15 Class B
	Harmonic Current	EN61000-3-2 / EN61000-3-3
Immunity	ESD	IEC/EN 61000-4-2 (Contact ±4KV / Air ±8KV)
	Surge	IEC/EN 61000-4-5 (Line - Line ±1KV, Line - GND ±2KV)
	PFMF	IEC/EN 61000-4-8
	Voltage Dips, Short Interruptions and Voltage Variations Immunity	IEC/EN 61000-4-11
Supply Chain		NDA & TAA Compliant

Product Characteristic Curve.

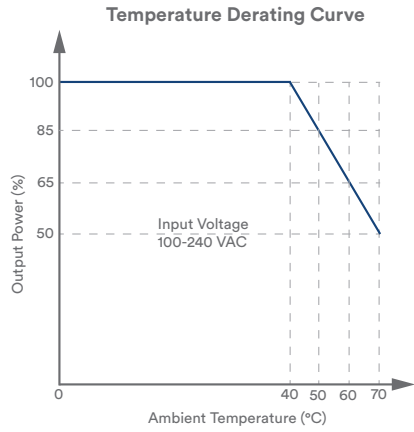

Product Dimensions.

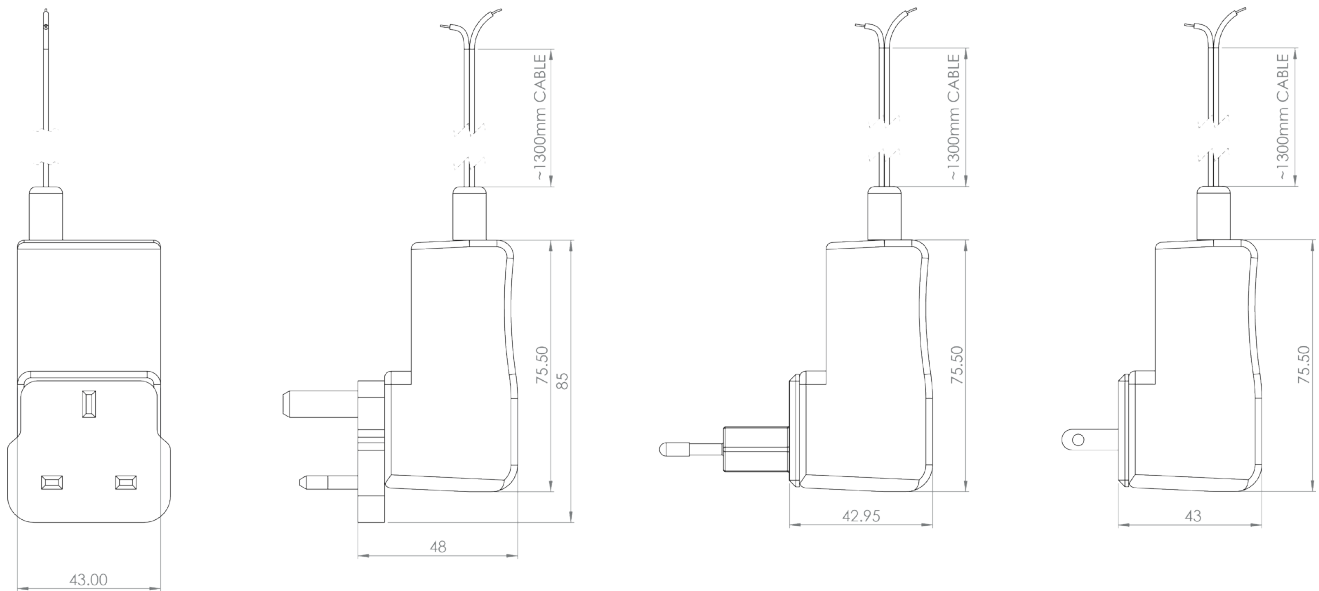

Part Numbers.

25W Light Industrial Plug-Top / Wall-Wart Power Supplies

AMGPSU-W12-P25	Light Industrial Plug-Top Power Supply, 12V Nominal Output, 25W (2.08A), UK/EU/US Heads
----------------	---

Notes.

Included Accessories: UK / EU / US user changeable plug heads included

Unless otherwise specified, parameters in this datasheet were measured under the conditions of $T_a=25^\circ\text{C}$. humidity <75% with nominal input voltage and rated output load.

In a continuing effort to improve and advance technology, product specifications are subject to change without notice. Please visit www.amgsystems.com for the latest product specifications.

