

H5A IR PTZ CAMERA

2 MP

4 MP

8 MP

The Avigilon H5A IR Pan, Tilt and Zoom (PTZ) camera empowers security teams to see more in the dark with an automated IR illumination range of up to 300 meters¹ and the ability to look-up 20 degrees above the horizon. Available in 2, 4 and 8 MP, the H5A IR PTZ delivers 360-degree views, up to 40x zoom² and high-resolution imaging for superior situational awareness of vast sites in the most challenging lighting conditions. Whether it's a completely dark airfield or a poorly lit parking lot, the H5A IR PTZ is ready to take on the outdoors with its ability to resist water, corrosion, dust and impact.



FEATURES



AUTOMATED IR ILLUMINATION

Sees up to 300 m¹ in complete darkness and ensures consistent scene illumination with the IR projection angle automatically adjusting to its zoom level and field of view.



NEXT-GENERATION VIDEO ANALYTICS WITH AUTO-TRACKING³

Detects more objects with expanded object classifications and automatically tracks objects in zone for faster, decisive responses.



OPERATIONAL RELIABILITY FOR TRAFFIC MONITORING

Meets NEMA TS2 environmental requirements for deployment in traffic monitoring applications.



FIPS 140-2 LEVEL 3 COMPLIANT WITH INTEGRATED TPM

FIPS 140-2 Level 3 compliance enables the camera to meet the data security standards that government agencies and heavily regulated enterprises require for deployment.



ABOVE THE HORIZON LOOK-UP

Provides more coverage than a typical PTZ camera with 360-degree views and the ability to look-up 20 degrees above the horizon.



WATER, CORROSION, DUST & IMPACT PROTECTION

Protects against water, dust, corrosion and impact with Type 4X, IP66/67/68 and IK10 ratings.



H.264 & H.265 HDSM SMARTCODEC™ TECHNOLOGY

Optimizes compression levels for regions in a scene to help maximize bandwidth savings and keep internet connectivity costs down.



ONVIF® COMPLIANT

ONVIF Profile S and T compliance enables easy integration with existing ONVIF infrastructures. Profile G compliance supports search, playback and retrieval of recordings on the edge.

¹300 m IR illumination range on the 2 MP, 150 m on the 4 and 8 MP

²40x zoom on the 2 MP, 36x zoom on the 4 and 8 MP

³Auto-tracking is estimated to be available in late 2022 via a camera firmware update.

ONVIF is a trademark of Onvif, Inc.

SPECIFICATIONS

IMAGE PERFORMANCE	2.0 MP	4.0 MP	8.0 MP
Image Sensor	1/2.8" progressive scan CMOS	1/2.5" Type "Exmor R" CMOS Sensor	
Active Pixels (H x V)	1937 (H) x 1097 (V)	2688 (H) x 1512 (V)	3840 (H) x 2160 (V)
Imaging Area (H x V)	4.8 mm (H) x 2.7 mm (V); 0.189" (H) x 0.106" (V)	6.25 mm (H) x 3.5 mm (V); 0.246" (H) x 0.137" (V)	
Minimum Illumination	0.3 lux (F/2.0) in color mode; 0.02 lux (F/2.0) in monochrome	0.3 lux (F/2.0) in color mode; 0.09 lux (F/2.0) in monochrome	
IR Range	300 m	150 m	
Dynamic Range	120 dB	100 dB	
Image Rate	Up to 60 fps	Up to 30 fps	
Aspect Ratio (Resolution Scaling)	Down to (16:9) 384 x 216 or (5:4) 320 x 256		
3D Noise Reduction Filter	Yes		

LENS	2.0 MP	4.0 MP	8.0 MP
Lens	4.25 to 170 mm, F/1.6, autofocus	4.4 mm to 88 mm, F/2.0 – F/3.8	
Angle of View Horizontal	66.35° – 1.9°	69.7° – 2.2°	
Zoom	40x (with image stabilization off), 30x (with image stabilization on)	36x (with image stabilization off), 30x (with image stabilization on)	

IMAGE CONTROL	
Video Compression	H.264 HDSM SmartCodec, H.265 HDSM SmartCodec, Motion JPEG
Streaming	Multi-stream H.264, Multi-stream H.265, Motion JPEG
Motion Detection	Pixel motion: Selectable sensitivity and threshold. Classified object detection
Electronic Shutter Control	Automatic, Manual (1/30 to 1/30,000 sec)
Iris Control	Automatic, Open, Closed
Day/Night Control	Automatic, Manual
Flicker Control	60 Hz, 50 Hz
White Balance	Automatic, Manual
Backlight Compensation	On/Off
Privacy Zones	3D, up to 64 zones
Presets	500 named presets
Tours	10 named tours
Audio Compression Method	G.711 PCM 8 kHz, Opus 48 kHz
Digital Zoom	Up to 100x when used with ACC™ Client for Windows
Electronic Image Stabilization	Yes
Digital Defog	Adjustable/Off

NETWORK	
Network	100BASE-TX
Cabling Type	CAT5e
Connector	RJ-45
ONVIF	ONVIF compliance version 1.02, 2.00, Profile S, Profile T, Profile G (www.onvif.org)
Security	Password protection, HTTPS encryption, digest authentication, WS authentication, user access log, 802.1x port based authentication, FIPS 140-2 L1 (with optional camera license), FIPS 140-2 L3 (with optional accessory)
Protocol	IPv6, IPv4, HTTP, HTTPS, SOAP, DNS, NTP, RTSP, RTCP, RTP, TCP, UDP, IGMPv2, ICMP, DHCP, Zeroconf, ARP, HSTS
Streaming Protocols	RTP/UDP, RTP/UDP multicast, RTP/RTSP/TCP, RTP/RTSP/HTTP/TCP, RTP/RTSP/HTTPS/TCP, HTTP
Device Management Protocol	SNMP v2c, SNMP v3

PERIPHERALS

Audio Input/Output	Line level input and output
External I/O Terminals	2 Alarm In, 2 Relay Out
Onboard Storage	MicroSD/microSDHC/microSDXC slot – video speed class card required. Class V10 or better recommended.

MECHANICAL

Dimensions (Ø × H)	(Ø) 250 mm × (H) 364 mm (Ø) 9.84 " × (H) 14.33 "
Weight	6.76 kg (14.9 lbs)
Front Window	Optical Glass Window -Ø 78 mm (3.07 ")
Wiper	Integrated with all options
Body	Aluminum ADC1 + Polycarbonate
Housing	Pendant Mount
Finish	Epoxy-polyester powder painted, standard colours grey-white (RAL9002)
Tilt	-20 ° to 90 °
Pan	Horizontal rotation: 360 °, continuous rotation

ELECTRICAL

Power Consumption	75 W max with 24 VDC aux power supply or 90 W PoE, 110 VA with 24 VAC aux power.	
Power Source	External Power	24 VDC ±10%; 24 VAC rms ±10%, 50 or 60 Hz
	PoE*	IEEE 802.3bt compliant Class 8 (90W) PoE: Pihong POE90U-1BT6-A-RC (Avigilon part number POE-INJ-BT-90W-NA)
Power Connector	Red and Black input wires	
RTC Backup Battery	3V manganese lithium	

* High power PoE is only guaranteed with the IEEE 802.3bt compliant Pihong POE90U-1BT (Avigilon part number POE-INJ-BT-90W-NA) .
Contact Avigilon sales or Avigilon technical support for more information

ENVIRONMENTAL

Operating Temperature	Continuous operation from -40 °C to + 60 °C (-40 °F to 140 °F) Wiper is functional at -10 °C to +60 °C (14 °F to 140 °F)
Storage Temperature	-10 °C to +70 °C (14 °F to 158 °F)
Humidity	5% to 95%, non-condensing
Wind Speed	Sustained 241 kph (150 mph)

CERTIFICATIONS

Certifications/Directives	UL, cUL, CE, UKCA, ROHS, RCM, NOM
Safety	UL 62368-1, CSA 62368-1, IEC/EN 62368-1, IEC/EN 62471
Environmental and Performance	UL/CSA/IEC 60950-22, IEC 62262 IK10 Impact Rating (enclosure only), IEC 60529 IP66, IP67, IP68 Weather Rating, IEC 60068-2-1, IEC 60068-2-2, IEC 60068-2-6, IEC 60068-2-30, NEMA TS 2, NEMA Type 4X
Electromagnetic Emissions	FCC Part 15 Subpart B Class B, IC ICES-003 Class B, EN 55032 Class B, EN 61000-6-3, EN 61000-3-2, EN 61000-3-3
Electromagnetic Immunity	EN 55035, EN 50130-4, EN 50121-4

ANALYTICS SPECIFICATIONS

SUPPORTED ANALYTICS EVENTS AT HOME POSITION

Objects in Area	The event is triggered when the selected object type moves into the region of interest causing the camera to automatically track the object. Returning to preset position once object is lost.
Object Loitering	The event is triggered when the selected object type moves into the region of interest and then stays for an extended amount of time.
Objects Crossing Beam	The event is triggered when the specified number of objects have crossed the directional beam that is configured over the camera's field of view. The beam can be unidirectional or bidirectional.
Object Appears or Enters Area	The event is triggered by each object that enters the region of interest. This event can be used to count objects.
Object Not Present in Area	The event is triggered when no objects are present in the region of interest.
Objects Enter Area	The event is triggered when the specified number of objects have entered the region of interest.
Objects Leave Area	The event is triggered when the specified number of objects have left the region of interest.
Object Stops in Area	The event is triggered when an object moves into a region of interest and then stops moving for the specified threshold time.
Direction Violated	The event is triggered when an object moves in the prohibited direction of travel.
Tamper Detection	The event is triggered when the scene unexpectedly changes.

SUPPORTED CLASSIFIED OBJECT TYPES

Object Types in Outdoor Mode	Vehicle, sub-types: Car, Truck, Bicycle, Motorcycle, Bus Person
Object Types in Indoor Mode	Person

TEACH BY EXAMPLE

Teach By Example	Yes, when used with Avigilon Control Center™
------------------	--

AVIGILON CONTROL CENTER (ACC) VERSIONS SUPPORTED FEATURES

ACC Version 6.14.12 or higher	All supported analytic events with two types of classified objects: person or vehicle. Appearance search when paired with appropriate server hardware. H.265 supported.
ACC Version 7.2 or higher	All supported analytic events with people and vehicles and all vehicle sub-types as classified objects. Appearance search when paired with appropriate server hardware. H.265 supported.

OUTLINE DIMENSIONS

H5A IR PTZ CAMERA (H5A-IR-PTZ)

[X.X]	INCHES
X	MM

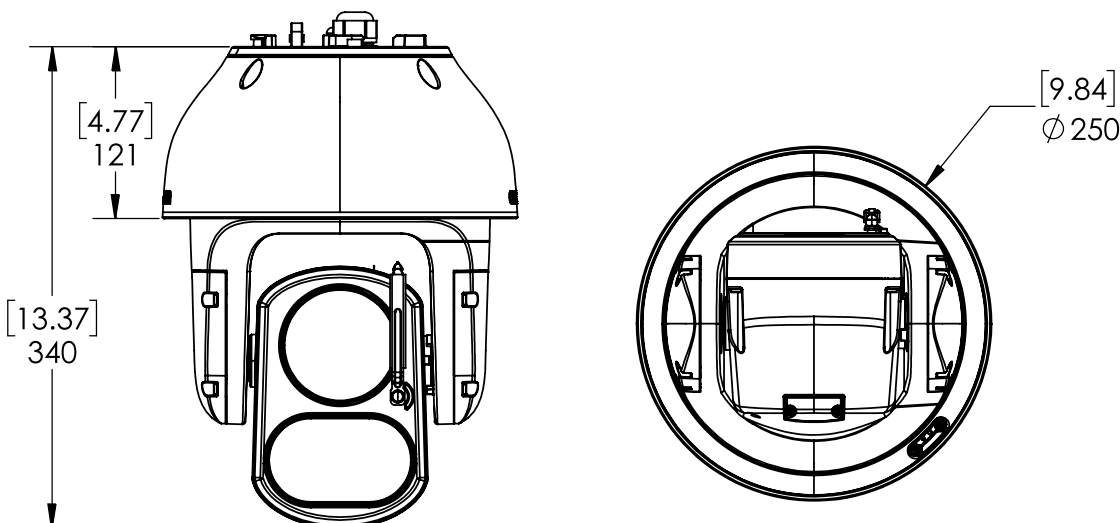

NPT MOUNT

(IRPTZ-MNT-NPTA1)

[X.X]	INCHES
X	MM

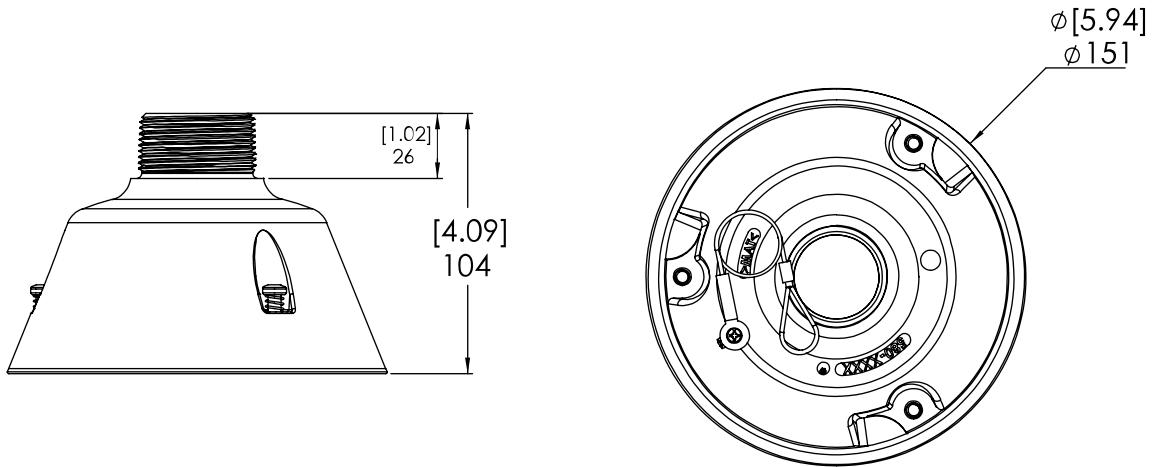

WALL MOUNT

(IRPTZ-MNT-WALL1)

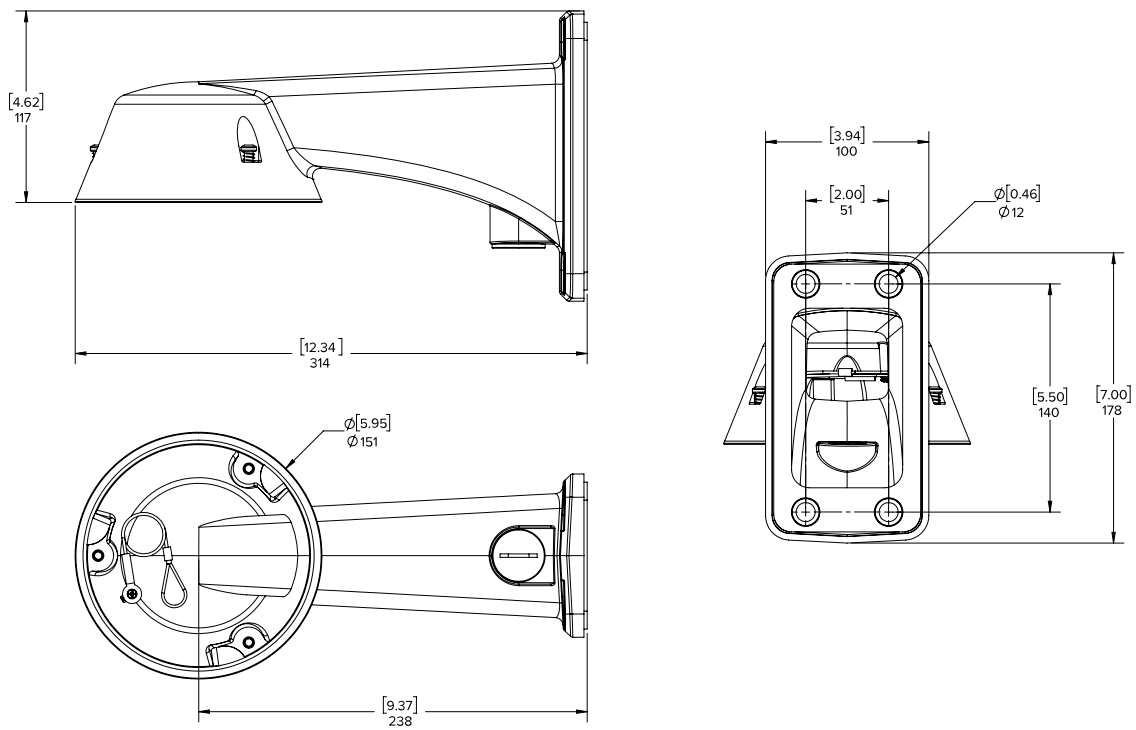

ORDERING INFORMATION

H5A IR PTZ CAMERAS

	MP	WDR	DIGITAL WDR	LIGHTCATCHER TECHNOLOGY	ANALYTICS AT HOME POSITION	ZOOM	HDSM SMARTCODEC
2.0C-H5A-IRPTZ-DP40-WP	2.0	✓		✓	✓	40x*	✓
4.0C-H5A-IRPTZ-DP36-WP	4.0		✓	✓	✓	36x*	✓
8.0C-H5A-IRPTZ-DP36-WP	8.0		✓	✓	✓	36x*	✓

* For all models, if image stabilization is turned on, max zoom will be 30x

CAMERA ACCESSORIES

	DESCRIPTION
IRPTZ-MNT-NPTA1	NPT Pendant Adapter
IRPTZ-MNT-WALL1	Wall Arm Mount
H4-MT-POLE1	Pole Mounting Bracket
H4-MT-CRNR1	Corner Mounting Bracket
POE-INJ-BT-60W-NA	Gigabit 802.3bt 60 W PoE Injector, single port
POE-INJ-BT-90W-NA	Gigabit 802.3bt 90 W PoE Injector, single port
H5PTZ-ACC-CABL1	Cable gland nut kit, pack of 10

SUPPORT

Learn more and find additional documentation at [avigilon.com](https://www.avigilon.com) or email sales@avigilon.com for specific product support.



Sep 2022 | Rev 2

© 2021 - 2022, Motorola Solutions, Inc. All rights reserved. MOTOROLA, MOTO, MOTOROLA SOLUTIONS, and the Stylized M Logo are trademarks or registered trademarks of Motorola Trademark Holdings, LLC and are used under license. AVIGILON, the AVIGILON logo, AVIGILON CONTROL CENTER, ACC, HDSM SmartCodec and LIGHTCATCHER are trademarks of Avigilon Corporation. The absence of the symbols ™ and ® in proximity to each trademark in this document or at all is not a disclaimer of ownership of the related trademark. All other trademarks are the property of their respective owners.