

VAR2-POE-w8-1 Medium Range White-Light PoE Illuminator



- Dedicated PoE Lighting for Network Systems
- Distances up to 180m (591ft)
- PLATINUM Elite SMT LED Technology
- Hot-spot Reduction Technology (HRT)
- VARIO Interchangeable Lens System
- VARIO Remote Control (optional)
- Angles from 10-120 degrees - from 1 product
- Excellent Colour Rendition

Delivering world leading power and illumination distances VARIO2 PoE illuminators can improve the performance of any video surveillance system at night. With PoE power input, the illuminators can be easily plugged into a network infrastructure, without the need for additional power supply units.

VARIO2 PoE illuminators use PLATINUM Elite SMT LED technology to deliver the highest levels of performance. The VARIO2 PoE series also offers a suite of advanced security features for easier programming and safer operation of smart lighting systems.

VARIO2 PoE features an interchangeable lens system with Hot-spot Reduction Technology to deliver highly even illumination, where it is most needed, for outstanding night-time images. With the optional hand-held remote control, VARIO2 PoE also makes installation and commissioning quicker, easier and safer.

The VARIO2 PoE w8-1 White-Light PoE illuminator delivers maximum distances up to 180m (591ft).

Product Dimensions

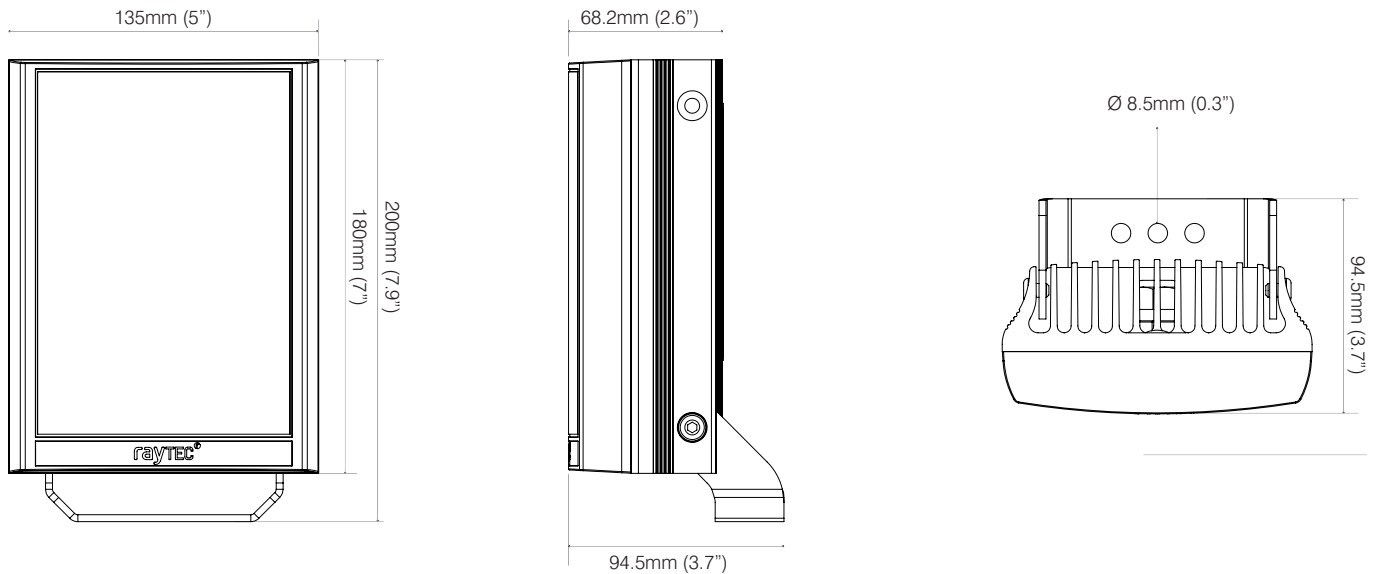

Features

POE Power Input

VARIO Interchangeable Lens System

Hot-spot Reduction Technology (HRT)

VARIO Remote Control (optional)

LED Status Indicator

Platinum Elite SMT LED Technology

Advanced Security Settings

Green Technology

Benefits

VARIO2 PoE illuminators can be plugged into the network infrastructure, offering a simple and low cost installation.

Angle of illumination can be easily, quickly and precisely adjusted by changing the VARIO holographic lens insert, to match the specific camera field of view.

HRT - hot-spot reduction technology delivers a highly diffused, elliptical beam shape to deliver more light where it is needed, generating both longer distances and minimizing light wastage. The HRT system also prevents overexposure of foreground objects.

Allows set up quickly and safely from ground level and provides access to advanced set up features. Reduces both cost and time of installation and commissioning.

Quick operational feedback on status and performance of the illuminator. Allows simple and quick commissioning of the installation and easy maintenance reviews

VARIO2 illuminators use cutting edge PLATINUM Elite SMT LED technology together with an enhanced Cool Running™ thermal management system to deliver World leading power, reliability and flexibility.

Programming inputs on both the VARIO remote control and on the VARIO 2 illuminator can be disabled if required. Additionally, the VARIO remote control can be given a PIN code to lock in settings and limit access.

In-built green features such as power adjust, telemetry control and timer function enhance the potential for energy savings.

5 YEAR WARRANTY

All Raytec luminaires are provided with an industry leading 5 year warranty and have an expected useful life in excess of 10 years



Technical Specifications

Illuminator

Total Lumens	3727lm per luminaire
Total Distance	180m (591ft)
Angle	Standard pack includes 10° circular + 35° x 10° (fitted as standard) and 60° x 25° elliptical lenses. Additional optional lenses: 80° x 30°, 120° x 50°
Input	60W PoE++ (4-pair PoE)* or 24V DC (24V DC Input available on Premium versions only)
Consumption	47W
Beam Shape	Elliptical with HRT (Hot-spot Reduction Technology)
Beam Angle System	VARIO Interchangeable Lens System
LED type	Platinum Elite SMT LEDs
Number of LEDs	24
Wavelength	White-Light
Colour Temp	6000K~
Colour Reproduction Index	>70
IP rating	IP66
Temperature Range	-50 to +50°C (-58 to 122°F)
Colour	Silver
Weight	1.65kg (3.6lbs)
Dimensions	135 x 180 x 68.2mm (5" x 7" x 3.2" approx)
Cable Length	2.5m
Bracketry	U bracket included VUB Bracketry also available (Optional)
Country of Manufacture	United Kingdom

*Compatible with MicroSemi/ PowerDSine and Phihong PSE devices, excluding Cisco. Contact Raytec for further information.

Integrated Command and Control Technology

Integrated Standard Features	<ul style="list-style-type: none"> Power adjust from 20-100% In-built photocell for automatic on/off operation Photocell sensitivity adjust LED status indicator provides status on performance of the unit LED status indicator on/off Disable programming mode
Advanced Features (accessed via VARIO remote control)	<ul style="list-style-type: none"> Timer function (up to 30 mins) Remote Dimming Restore factory default settings Optional PIN to lock in settings and limit access Remote Control can be disabled for improved security
Advanced Features available on VARIO2 PoE Premium variants (contact Raytec)	<ul style="list-style-type: none"> Telemetry input Photocell following output 24V DC power input

POWERS – The Open Lighting Standard

Specifications and distances based on the POWERS lighting standard. For full POWERS data and A&E specifications please contact sales@rayteccctv.com

Product Codes

Part Codes	Description	Angles	Distances
VAR2-POE-w8-1	VARIO2 w8 PoE standard pack, 10°x10°, 35°x10° and 60°x25° angles included, PoE++, silver, white-light	10 x 10 °	180m (591ft)
		35 x 10° (fitted as standard)	95m (312ft)
		60 x 25°	50m (164ft)
		80 x 30° (optional)	35m (115ft)
		120 x 50° (optional)	25m (82ft)

Premium version available – Add "PR" to the end of part code (Premium variants include 24V DC input, Photocell following contact, and Telemetry input)

Optional Parts

VAR-rc	Remote Control for any VARIO illuminator (only 1 remote needed)
VAR-w8-LENS-8030	Individual w8 VARIO lens – 80°H x 30°V
VAR-w8-LENS-12050	Individual w8 VARIO lens – 120°H x 50°V