

# SENTECH

## Analog 600 Series Product Specifications



### Features

- Various Connector Types
- Cased or Board Models
- .25 or .4 Megapixel Resolutions
- 16 DIP Switches

## Safety Precautions

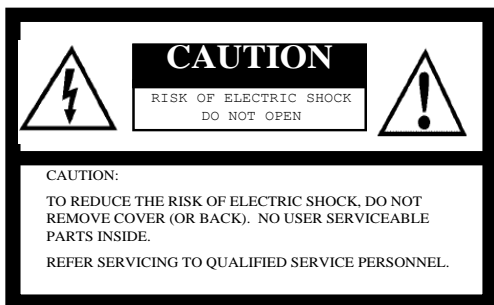

The lightning flash with arrowhead symbol, within an equilateral triangle, is intended to alert the user to the presence of uninsulated “dangerous voltage” within the product’s enclosure that may be of sufficient magnitude to constitute a risk of electric shock to persons.



The exclamation point within an equilateral triangle is intended to alert the user to the presence of important operating and maintenance (servicing) instructions in the literature accompanying the appliance.

For U.S.A.

Warning:

This equipment generates and uses radio frequency energy and if not installed and used properly, I.e., in strict accordance with the instruction manual, may cause harmful interference to radio communications. It has been tested and found to comply with the limits for a Class A computing device pursuant to Subpart J of Part 15 of FCC Rules, which are designed to provide reasonable protection against such interference when operated in a commercial environment.

For Canada

Warning:

This digital apparatus does not exceed the Class A limits for radio noise emissions from digital apparatus set out in the Radio Interference Regulations of the Canadian Department of Communications.

WARNING:

TO PREVENT FIRE OR SHOCK HAZARD, DO NOT EXPOSE THIS APPLIANCE TO RAIN OR MOISTURE.

## Product Precautions

- Handle the camera with care. Do not abuse the camera. Avoid striking or shaking it. Improper handling or storage could damage the camera.
- Do not pull or damage the camera cable.
- During camera use, do not wrap the unit in any material. This will cause the internal temperature of the unit to increase.
- Do not expose the camera to moisture, or do not try to operate it in wet areas.
- Do not operate the camera beyond its temperature, humidity and power source ratings.
- While the camera is not being used, keep the lens or lens cap on the camera to prevent dust or contamination from getting in the CCD or filter area and scratching or damaging this area.
- Do not keep the camera under the following conditions:
  - In wet, moist, and high humidity areas
  - Under hot direct sunlight
  - In high temperature areas
  - Near an object that releases a strong magnetic or electric field
  - Areas with strong vibrations
- Use a soft cloth to clean the camera. Use pressured air spray to clean the surface of the glass. DO not scratch the surface of the glass.

## Copyright & Disclaimer

Sensor Technologies America, Inc. (DBA Sentech America) believes the contents and specifications of its website, catalog, documentation and ads are correct; however, Sentech America provides no representation or warranty regarding such information or product(s) contained therein. It is requested that Sentech America be given appropriate acknowledgement in any subsequent use of such work by a third party.

While every effort has been made to ensure that the details contained in Sentech America's website and all documentation are correct and up-to-date, Sentech America assumes no liability, legal or otherwise for any errors in listings, specifications, part numbers, process, software or model applications. Sentech America reserves the right to change specifications, product descriptions, product quality, pricing and application at any time without prior written or oral notice. Any party using such information assumes all risk for any and all damaged caused to themselves, a third party and/or property by virtue of incorrect information and/or failure of these products. By installing and/or using a Sentech America software development kit or other similar product and/or information obtained from Sentech America's website, catalog, documentation or ads, you hereby accept and understand these stated terms and conditions.

## Contents

|  |    |
|--|----|
| 1. Introduction .....  | 5  |
| 1.1 Changes from the Original Series.....                                  | 5  |
| 1.1.1 New Model Line Up .....  | 5  |
| 1.1.2 Difference of Specifications .....                                   | 5  |
| 1.1.3 Control Software .....   | 9  |
| 1.1.4 Communication Equipment .....  | 9  |
| 1.1.5 New Functions .....  | 9  |
| 1.2 Video Signal Comparison .....  | 10 |
| 1.3 Naming Method .....  | 10 |
| 2. Electronic Specifications .....   | 11 |
| 2.1 STC-620 / 625 .....  | 11 |
| 2.2 STC-H620 / H625 .....  | 12 |
| 2.3 STC-630 / 635 .....  | 13 |
| 3. Spectral Sensitivity Characteristics .....                              | 14 |
| 3.1 STC-620 / 625 (ICX418AKL) .....  | 14 |
| 3.2 STC-625 (ICX419AKL).....   | 14 |
| 3.3 STC-H620 (ICX828AK).....   | 15 |
| 3.4 STC-H625 (ICX829AKA(TBD)) .....  | 15 |
| 3.5 STC-630 (ICX638BKA) .....  | 15 |
| 3.6 STC-635 (ICX639BKA) .....  | 16 |
| 4. Description of the Back Panel .....                                     | 17 |
| 4.1 Cased: PWT Model .....   | 17 |
| 4.2 Cased: PWJ Model.....  | 18 |
| 4.3 Cased: PWC Model.....  | 19 |
| 4.4 Board: PII,LII,CSII Common Specifications .....                        | 20 |
| 5. Dimensions.....   | 21 |
| 5.1 Cased (C-Mount): PWT, PWJ, PWC .....                                   | 21 |
| 5.2 Cased (CS-Mount): PWT, PWJ, PWC .....                                  | 22 |
| 5.3 Board: PII Model .....   | 22 |
| 5.4 Board: LII Model.....  | 24 |
| 5.5 Board: CSII Model .....  | 25 |
| 6. Camera Set Up .....   | 26 |
| 7. Communication Protocol Specifications and Control Software Manual ..... | 26 |

---

|  |    |
|--|----|
| 7.1 Communication Settings.....                      | 26 |
| 7.2 Communication Format .....                       | 26 |
| 7.2.1 Specifications for the Commands Sent .....     | 26 |
| 7.2.2 Specification of the Data Received .....       | 29 |
| 7.3 Camera Control Command and Software Manual ..... | 31 |
| 7.3.1 Port Driver Function.....                      | 31 |
| 7.3.2 Shutter / Gain.....                            | 32 |
| 7.3.3 Chroma.....                                    | 43 |
| 7.3.4 Gamma.....                                     | 47 |
| 7.3.5 BLC (Back Light Compensation) .....            | 50 |
| 7.3.6 White Balance .....                            | 55 |
| 7.3.7 ME .....                                       | 57 |
| 7.3.8 Aperture.....                                  | 63 |
| 7.3.9 Other .....                                    | 65 |

## 1. Introduction

This specification describes the following cameras:

STC-620/625, STC-H620/H625, STC-630/635

### 1.1 Changes from the Original Series

STC-620/625, 630/635, and STC-H620/H625 (Sentech 600 Series) will be discontinued as of (TBD). New models of the 600 Series have now been released; however some parts of the camera will not be the same as the original series. Please refer to the chart below for further information on these changes.

#### 1.1.1 New Model Line Up

| Specification   |             |  |                    |             |
|-----------------|-------------|--|--------------------|-------------|
| Number of Pixel | View        | NTSC/PAL   | Back Panel         |             |
|                 |             |  | Current Model      | New Model   |
| 0.25 Mega Pixel | Case        | STC-530/535<br>STC-540/545<br><b>Same as H model</b> | All                | Discontinue |
|                 |             |  | BTII               |             |
|                 |             |  | BJII               |             |
|                 |             |  | CT                 |             |
|                 |             |  | CC                 |             |
|                 | Board       | STC-530/535<br>STC-540/545<br><b>Same as H model</b> | PII<br>LII<br>CSII | Discontinue |
| 0.4 Mega Pixel  | Case/ Board | STC-640/645  | All model          | Discontinue |
| 0.4 Mega Pixel  | Case        | STC-620/625<br>STC-H620/H625<br>STC-630/635          | All                | Discontinue |
|                 |             |  | BTII               | PWT         |
|                 |             |  | BJII               | PWJ(NEW)    |
|                 |             |  | CT                 | PWT         |
|                 |             |  | CC                 | PWC         |
|                 | Board       | STC-620/625<br>STC-H620/H625                         | C                  | C3          |
|                 |             |  | Blank              | No-Mount    |
|                 |             | STC-630/635  | PII                | Discontinue |
|                 |             |  | LII                | L3          |
| CSII            | CS3         |  |                    |             |
| Blank           | No-Mount    |  |                    |             |

#### 1.1.2 Difference of Specifications

##### Sensor Specifications

CCD Sensors will be changed as per the following chart:

| Product         | Original Model   | New Model        |
|-----------------|------------------|------------------|
| STC-620/625     | ICX418AKL/419AKL | ICX418AKL/419AKL |
| STC-H620/ H 625 | ICX428AKL/429AK  | ICX828AK/829AK   |
| STC-630/635     | ICX408AK/409AK   | ICX638BKA/639BKA |

## Switch Specifications

- Volume switch has been removed.
- Assignment of the DIP Switch (ON/OFF): This is the same as the original. (Internal circuit is modified as OFF: High, ON: Low)
- There are now 16 DIP Switches.
- Functions that are assigned will be modified.

### Original Model

| SW No. | Function                 | OFF      | ON       |
|--------|--------------------------|----------|----------|
| 1      | White Balance            | Auto     | Manual   |
| 2      | AGC                      | ON       | OFF      |
| 3      | Shutter Speed Setting    |          |          |
| 4      |                          |          |          |
| 5      |                          |          |          |
| 6      | Shutter Mode Setting     |          |          |
| 7      |                          |          |          |
| 8      | Negative / Positive Mode | Positive | Negative |

| SW 3 | SW 4 | SW 5 | Fixed Shutter Speed |           |
|------|------|------|---------------------|-----------|
|      |      |      | High Speed          | Low Speed |
| OFF  | OFF  | OFF  | 1/60                | 2Feld     |
| ON   | OFF  | OFF  | 1/125               | 4Feld     |
| OFF  | ON   | OFF  | 1/250               | 6Feld     |
| ON   | ON   | OFF  | 1/500               | 8Feld     |
| OFF  | OFF  | ON   | 1/1000              | 10Feld    |
| ON   | OFF  | ON   | 1/2000              | 12Feld    |
| OFF  | ON   | ON   | 1/4000              | 14Feld    |
| ON   | ON   | ON   | 1/10000             | 16Feld    |

| SW 6 | SW 7 | Shutter Mode  |
|------|------|---|
| OFF  | OFF  | High Speed Shutter Mode                                 |
| OFF  | ON   | Flicker Less Shutter Mode<br>(1/100 【/120PAL】sec Fixed) |
| ON   | OFF  | Low Speed Shutter Mode                                  |
| ON   | ON   | Electrical IRIS Mode (1/60 【/50PAL】~1/10.000)           |

### New Model

| SW    | No. | Function  | OFF             | ON            |
|-------|-----|---|-----------------|---------------|
| SW201 | 1   | Shutter Mode  | Electrical IRIS | Fixed Shutter |
|       | 2   | Shutter Speed<br>(SW201-1-ON: Available)  |                 |               |
|       | 3   |   |                 |               |
|       | 4   |   |                 |               |
|       | 5   |   |                 |               |
|       | 6   | Flicker Compensation Mode<br>(SW201-1-OFF: Available)   |                 |               |
|       | 7   | Back Light Compensation<br>(SW201-1-ON: Available)  | OFF             | ON            |
|       | 8   | Back Light Correction<br>Mode<br>(SW201-7-ON: Available)  | Auto Weight     | Fixed Weight  |
| SW202 | 1   | Low Luminance Control<br>(SW201-1-OFF: Available)<br><small>Note: AGC is available SW201-1 ON and OFF</small> |                 |               |
|       | 2   |   |                 |               |
|       | 3   |   |                 |               |
|       | 4   | WB  | Auto            | Push to Set   |
|       | 5   | Image Flip  |                 |               |
|       | 6   |   |                 |               |
|       | 7   | Gamma   | 0.45 (Preset)   | 1.0 (Manual)  |
|       | 8   |   |                 |               |

| SW 2 | SW 3 | SW 4 | Shutter Speed |
|------|------|------|---------------|
| OFF  | OFF  | OFF  | 1/60          |
| ON   | OFF  | OFF  | 1/125         |
| OFF  | ON   | OFF  | 1/250         |
| ON   | ON   | OFF  | 1/500         |
| OFF  | OFF  | ON   | 1/1000        |
| ON   | OFF  | ON   | 1/2000        |
| OFF  | ON   | ON   | 1/4000        |
| ON   | ON   | ON   | 1/10000       |

| SW 5 | SW 6 | Flicker Compensation Mode |
|------|------|---------------------------|
| OFF  | OFF  | OFF                       |
| ON   | OFF  | Flicker Less              |
| OFF  | ON   | Gain Modification         |
| ON   | ON   | -                         |

| SW 9 | SW 10 | SW 11 | Low Luminance Control     |
|------|-------|-------|---------------------------|
| OFF  | OFF   | OFF   | AGC, Sbw Shutter OFF      |
| ON   | OFF   | OFF   | AGC                       |
| OFF  | ON    | OFF   | Sbw Shutter ON            |
| ON   | ON    | OFF   | AGC -> Sbw Shutter        |
| OFF  | OFF   | ON    | Sbw Shutter -> AGC        |
| ON   | OFF   | ON    | AGC -> Sbw Shutter -> AGC |
| OFF  | ON    | ON    | -                         |
| ON   | ON    | ON    | -                         |

| SW 13 | SW 14 | Image Flip          |
|-------|-------|---------------------|
| OFF   | OFF   | OFF (Normal)        |
| ON    | OFF   | Vertical            |
| OFF   | ON    | Horizontal          |
| ON    | ON    | Horizontal/Vertical |

## Factory Default Settings (All Models)

| SW    | No. | OFF | ON |
|-------|-----|-----|----|
| SW201 | 1   |     | ●  |
|       | 2   | ●   |    |
|       | 3   | ●   |    |
|       | 4   | ●   |    |
|       | 5   | ●   |    |
|       | 6   | ●   |    |
|       | 7   | ●   |    |
|       | 8   | ●   |    |
| SW202 | 1   |     | ●  |
|       | 2   | ●   |    |
|       | 3   | ●   |    |
|       | 4   | ●   |    |
|       | 5   | ●   |    |
|       | 6   | ●   |    |
|       | 7   | ●   |    |
|       | 8   | ●   |    |

### Caution

- Internal Sync is unstable while adjusting the phase of the input and output signal on External Sync.
- External Sync may work in Internal Sync (Factory default) mode, however External Sync is not in phase with Internal Sync.
- To set the internal sync again, please reset the camera after internal sync has been selected.



## Back Panel Specifications

### Example:

PWC Model(same as PWT)

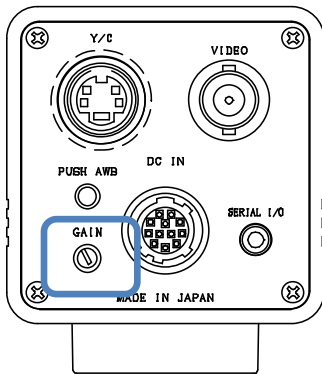

L2 Model

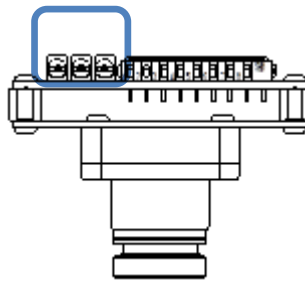

- □ Gain, WB Volume is removed (but these parameters can be set through the control software)

[Current Model]

BTII

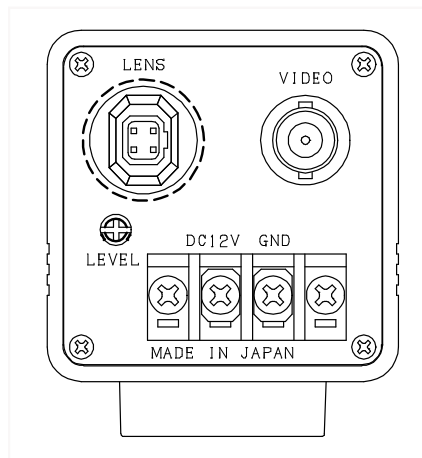

[New Model]

PWT

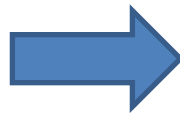
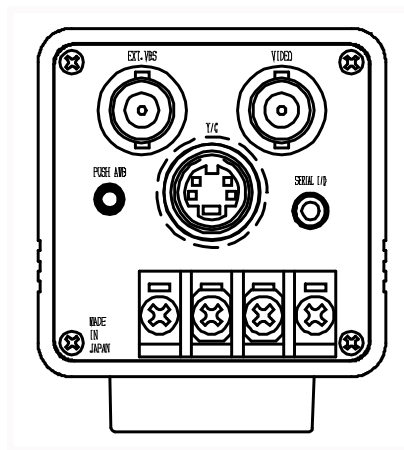

[Current Model]

BJII

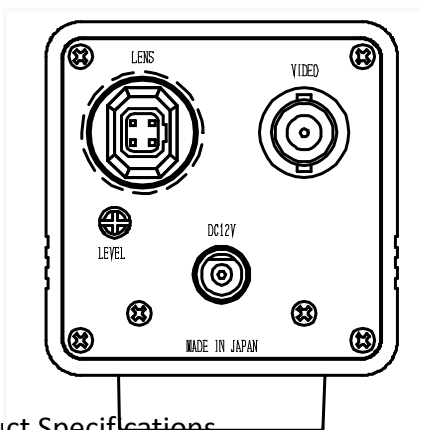

[New Model]

PWJ

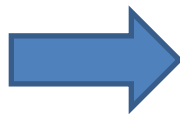
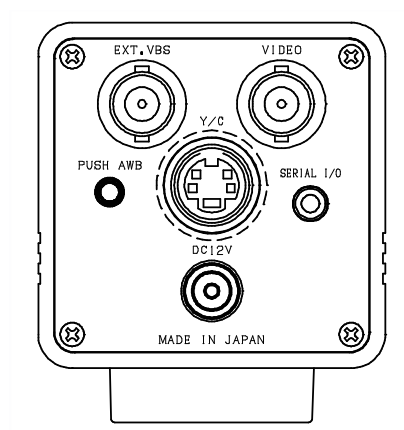

[Current Model]

CC

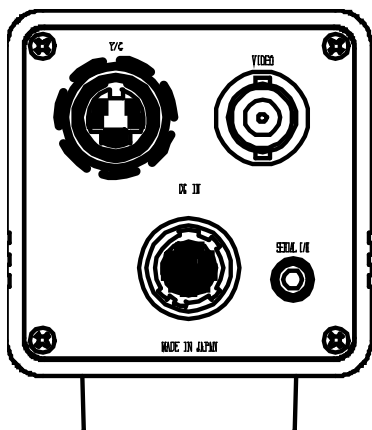

[New Model]

PWC

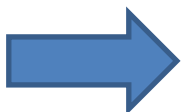
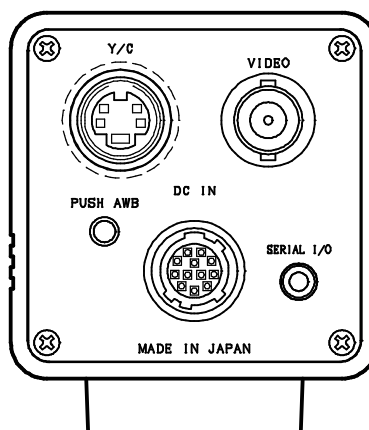

[Current Model]

CT

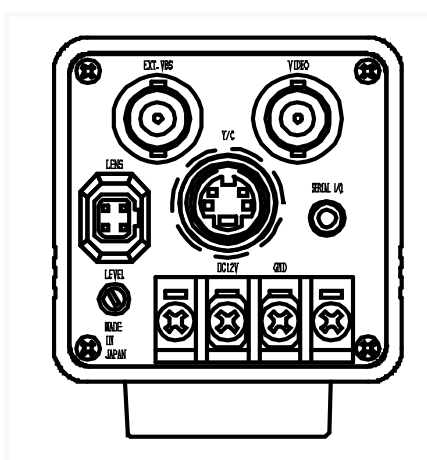

[New Model]

PWT

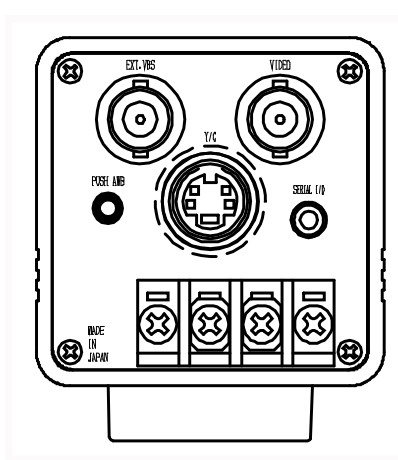

### 1.1.3 Control Software

New Control Software will be released for the new DSP.

### 1.1.4 Communication Equipment

Previously used communication equipment that was compatible with the original 600 Series will work with the new series.

### 1.1.5 New Functions

Memory will be implemented into the camera and the following new functions can now be used:

- Horizontal / Vertical Flip
- Slow Shutter (Max: TBD Sec)
- Still Image

## 1.2 Video Signal Comparison

Further measurements must be done. Video Signal Comparison will be updated in a future update.

## 1.3 Naming Method

# STC-x6xx-xxx

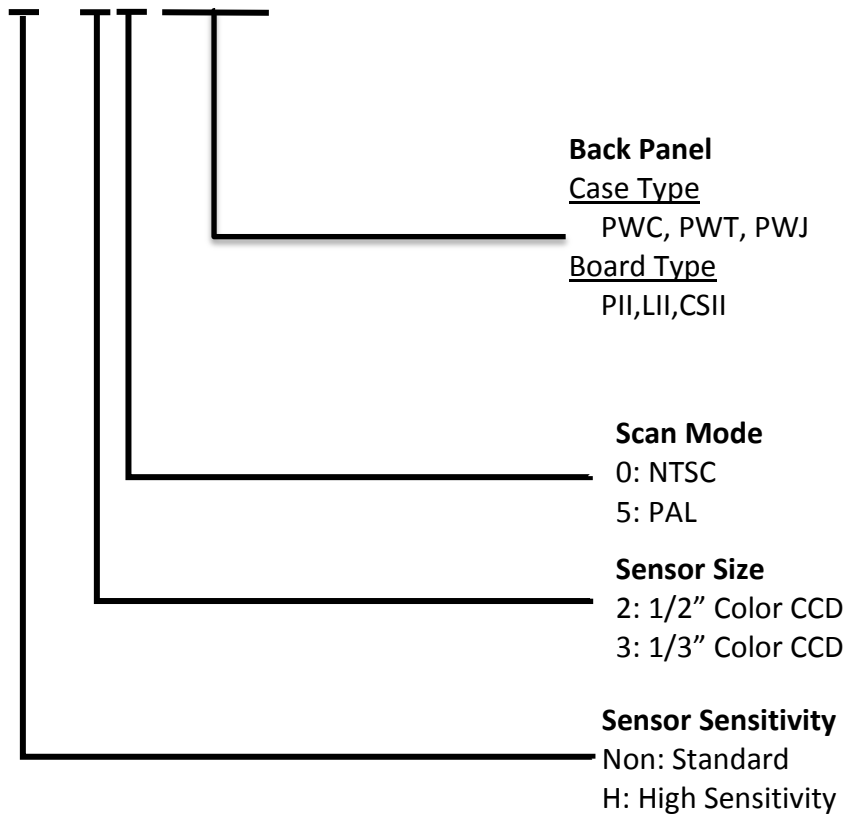

## 2. Electronic Specifications

### 2.1 STC-620 / 625

| Model Number               | STC-620(NTSC)  | STC-625(PAL)   |
|----------------------------|--|--|
| Image Sensor               | 1/2 inch Interline CCD<br>ICX418AKL  | 1/2 inch Interline CCD<br>ICX 419AKL                         |
| Active Picture Elements    | 768(H) x 494(V)  | 752(H) x 582(V)  |
| Signal Format              | NTSC   | PAL  |
| Scanning System            | 2:1 Interlace  |  |
| Scanning Frequency         | Horizontal Frequency 15.734kHz<br>Vertical Frequency 59.94Hz   | Horizontal Frequency 15.625kHz<br>Vertical Frequency 50.00Hz |
| Sync. System               | Internal / External  |  |
| Horizontal Resolution      | 480TV Lines  |  |
| S/N Ratio                  | More than 48dB (AGC=OFF)   |  |
| Video Output Format        | VBS 1.0Vp-p 75 Ω 、 Y/C   |  |
| Minimum Scene illumination | 0.11 lx, F1.2 (AGC=ON)   |  |
| Electronic Shutter         | <b>[Dip Switch]</b><br>1/60(1/50:PAL), 1/125, 1/250, 1/500, 1/1000, 1/2000, 1/4000, 1/10000 sec<br><b>[Auto/Control Software]</b><br>High Speed Shutter: 1/60(1/50:PAL), 1/125, 1/250, 1/500, 1/1000, 1/2000, 1/4000, 1/10000, 1/100000 sec<br>Low Speed Shutter: 1 to 256FLD(Configurable through the control software) |  |
| White Balance              | Auto / Push to Set/ Manual (Configurable through the control software)   |  |
| Auto IRIS                  | Non-Support  |  |
| AGC                        | ON / OFF   |  |
| Gamma                      | 0.45/1.0 (Switchable, Configurable through the control software),<br>Default:0.45  |  |
| Image Rotation             | Normal (Default),Horizontal Flip, Vertical Flip, Horizontal Vertical Flip  |  |
| Still Image                | Support  |  |
| Lens Mount                 | C Mount  |  |
| Optical LPF                | IR Cut Filter with Optical LPF   |  |
| Input Voltage              | DC9V~15V   |  |
| Power Consumption          | 95mA ± 20mA  |  |
| Operational Temperature    | -10°C - +50°C  |  |
| Storage Temperature        | -30°C - +60°C  |  |
| Dimensions                 | Board Type : 45(W) x 45(W) x (D) mm, refer to Dimensions※1<br>Case Type: 51(W) x 51(H) x Approximately 60.5(D) mm ※1   |  |
| Weight                     | Board Type: Approximately TBD g<br>Case Type : Approximately 190 g   |  |
| RoHS                       | RoHS Compliance  |  |

## 2.2 STC-H620 / H625

| Model Number               | STC-H620(NTSC)   | STC-H625(PAL)  |
|----------------------------|--|--|
| Image Sensor               | 1/2 inch Interline CCD<br>ICX828AK   | 1/2 inch Interline CCD<br>ICX/829AK(TBD)                     |
| Active Picture Elements    | 768(H) x 494(V)  | 752(H) x 582(V)  |
| Signal Format              | NTSC   | PAL  |
| Scanning System            | 2:1 Interlace  |  |
| Scanning Frequency         | Horizontal Frequency 15.734kHz<br>Vertical Frequency 59.94Hz   | Horizontal Frequency 15.625kHz<br>Vertical Frequency 50.00Hz |
| Sync. System               | Internal / External  |  |
| Horizontal Resolution      | 480TV Lines  |  |
| S/N Ratio                  | More than 48dB (AGC=OFF)   |  |
| Video Output Format        | VBS 1.0Vp-p 75Ω、Y/C  |  |
| Minimum Scene illumination | TBD lx, F1.2 (AGC=ON)  |  |
| Electronic Shutter         | <b>[Dip Switch]</b><br>1/60(1/50:PAL), 1/125, 1/250, 1/500, 1/1000, 1/2000, 1/4000, 1/10000 sec<br><b>[Auto/Control Software]</b><br>High Speed Shutter: 1/60(1/50:PAL), 1/125, 1/250, 1/500, 1/1000, 1/2000, 1/4000, 1/10000, 1/100000 sec<br>Low Speed Shutter: 1 to 256FLD(Configurable through the control software) |  |
| White Balance              | Auto / Push to Set/ Manual (Configurable through the control software)   |  |
| Auto IRIS                  | Non-Support  |  |
| AGC                        | ON / OFF   |  |
| Gamma                      | 0.45/1.0 (Switchable, Configurable through the control software),<br>Defalut:0.45  |  |
| Image Rotation             | Normal (Default),Horizontal Flip, Vertical Flip, Horizontal Vertical Flip  |  |
| Still Image                | Support  |  |
| Lens Mount                 | C Mount  |  |
| Optical LPF                | IR Cut Filter with Optical LPF   |  |
| Input Voltage              | DC9V~15V   |  |
| Power Consumption          | TBD (170mA ± 20mA)   |  |
| Operational Temperature    | TBD (-10°C - +45°C)  |  |
| Storage Temperature        | TBD (-20°C - +60°C)  |  |
| Dimensions                 | Board Type : 45(W) x 45(W) x (D) mm, refer to Dimensions※1<br>Case Type: 51(W) x 51(H) x Approximately 60.5(D) mm ※1   |  |
| Weight                     | Board Type: Approximately TBD g<br>Case Type : Approximately TBD g   |  |
| RoHS                       | RoHS Compliance  |  |

## 2.3 STC-630 / 635

| Model Number               | STC-630(NTSC)  | STC-635(PAL)   |
|----------------------------|--|--|
| Image Sensor               | 1/3 inch Interline CCD<br>ICX638BKA  | 1/3 inch Interline CCD<br>ICX639BKA                          |
| Active Picture Elements    | 768(H) x 494(V)  | 752(H) x 582(V)  |
| Signal Format              | NTSC   | PAL  |
| Scanning System            | 2:1 Interlace  |  |
| Scanning Frequency         | Horizontal Frequency 15.734kHz<br>Vertical Frequency 59.94Hz   | Horizontal Frequency 15.625kHz<br>Vertical Frequency 50.00Hz |
| Sync. System               | Internal / External  |  |
| Horizontal Resolution      | 480TV Lines  |  |
| S/N Ratio                  | More than 48dB (AGC=OFF)   |  |
| Video Output Format        | VBS 1.0Vp-p 75Ω、Y/C  |  |
| Minimum Scene illumination | 0.11 lx, F1.2 (AGC=ON)   |  |
| Electronic Shutter         | <b>[Dip Switch]</b><br>1/60(1/50:PAL), 1/125, 1/250, 1/500, 1/1000, 1/2000, 1/4000, 1/10000 sec<br><b>[Auto/Control Software]</b><br>High Speed Shutter: 1/60(1/50:PAL), 1/125, 1/250, 1/500, 1/1000, 1/2000, 1/4000, 1/10000, 1/100000 sec<br>Low Speed Shutter: 1 to 256FLD(Configurable through the control software) |  |
| White Balance              | Auto / Push to Set/ Manual (Configurable through the control software)   |  |
| Auto IRIS                  | Non-Support  |  |
| AGC                        | ON / OFF   |  |
| Gamma                      | 0.45/1.0 (Switchable, Configurable through the control software),<br>Defalut:0.45  |  |
| Image Rotation             | Normal (Default),Horizontal Flip, Vertical Flip, Horizontal Vertical Flip  |  |
| Still Image                | Support  |  |
| Lens Mount                 | CS Mount   |  |
| Optical LPF                | IR Cut Filter with Optical LPF   |  |
| Input Voltage              | DC9V~15V   |  |
| Power Consumption          | 80mA ± 20mA  |  |
| Operational Temperature    | -10°C - +50°C  |  |
| Storage Temperature        | -30°C - +60°C  |  |
| Dimensions                 | Board Type : 45(W) x 45(W) x (D) mm, refer to Dimensions※1<br>Case Type: 51(W) x 51(H) x Approximately 55.5(D) mm ※1   |  |
| Weight                     | Board Type: Approximately TBD g<br>Case Type : Approximately 190 g   |  |
| RoHS                       | RoHS Compliance  |  |

## 3. Spectral Sensitivity Characteristics

### 3.1 STC-620 / 625 (ICX418AKL)

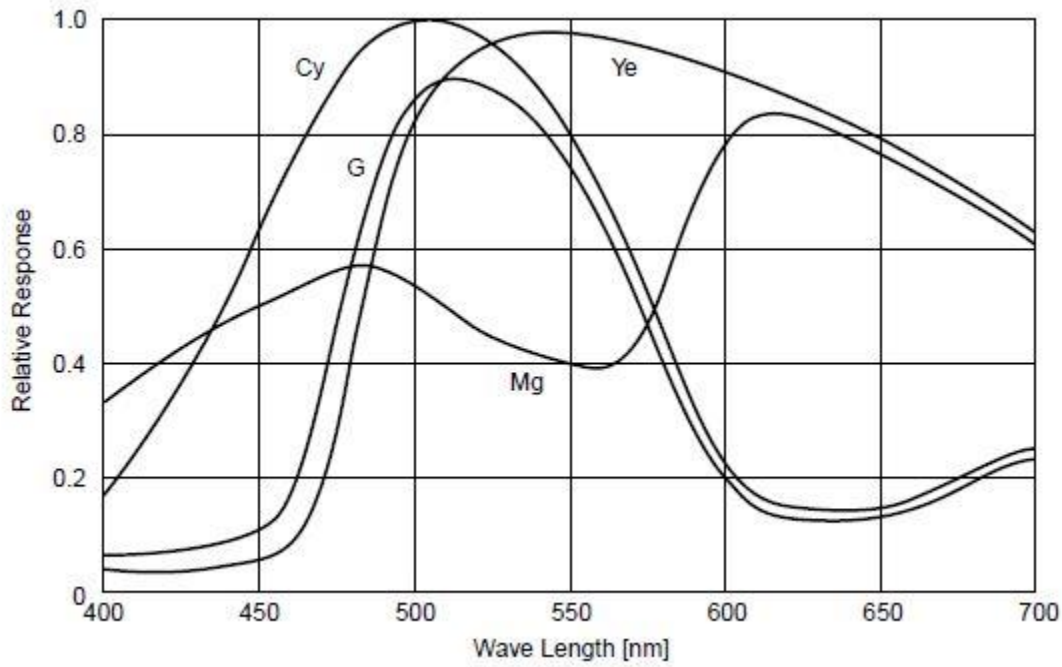

### 3.2 STC-625 (ICX419AKL)

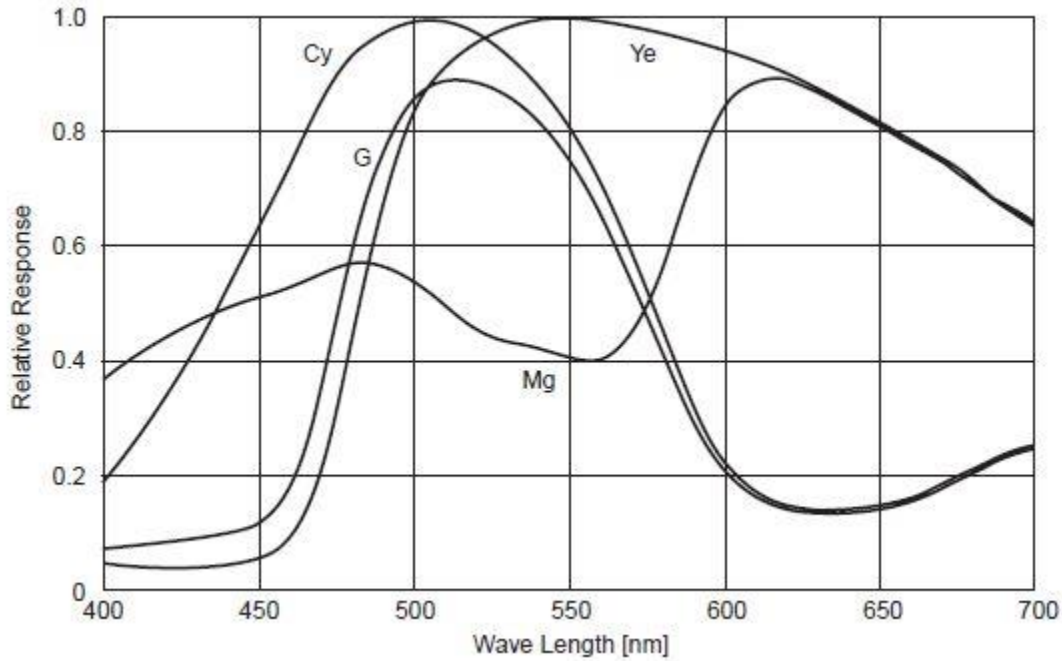

### 3.3 STC-H620 (ICX828AK)

TBD

### 3.4 STC-H625 (ICX829AKA(TBD))

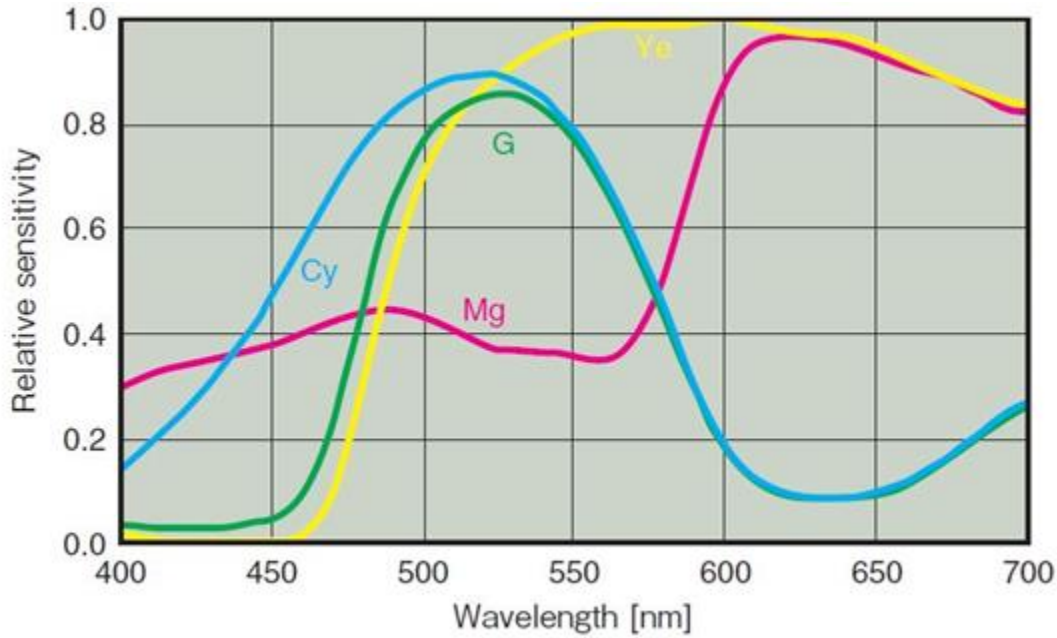

### 3.5 STC-630 (ICX638BKA)

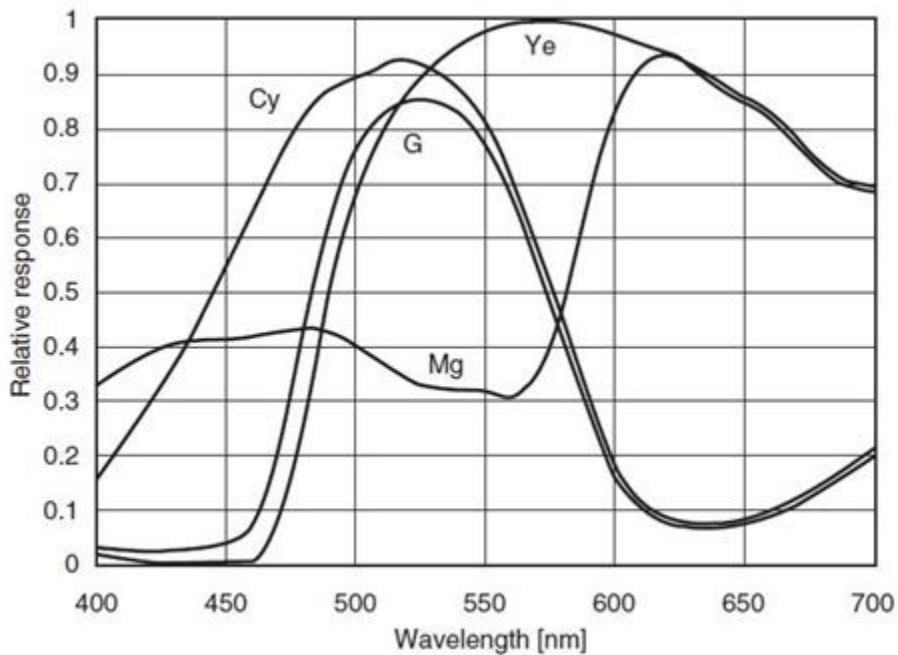



## 3.6 STC-635 (ICX639BKA)

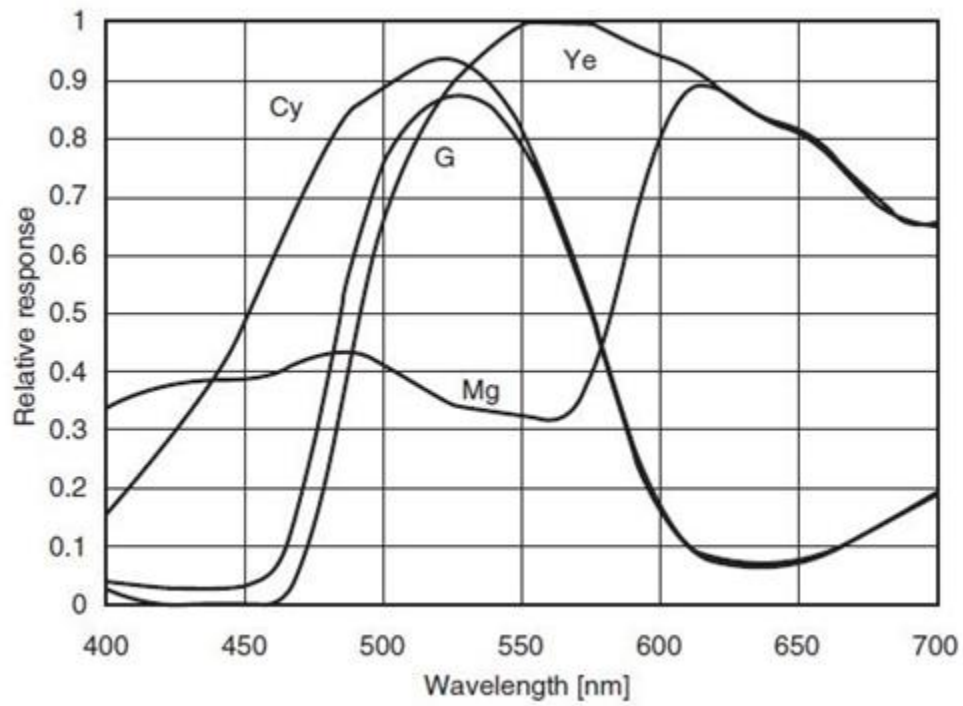

## 4. Description of the Back Panel

### 4.1 Cased: PWT Model

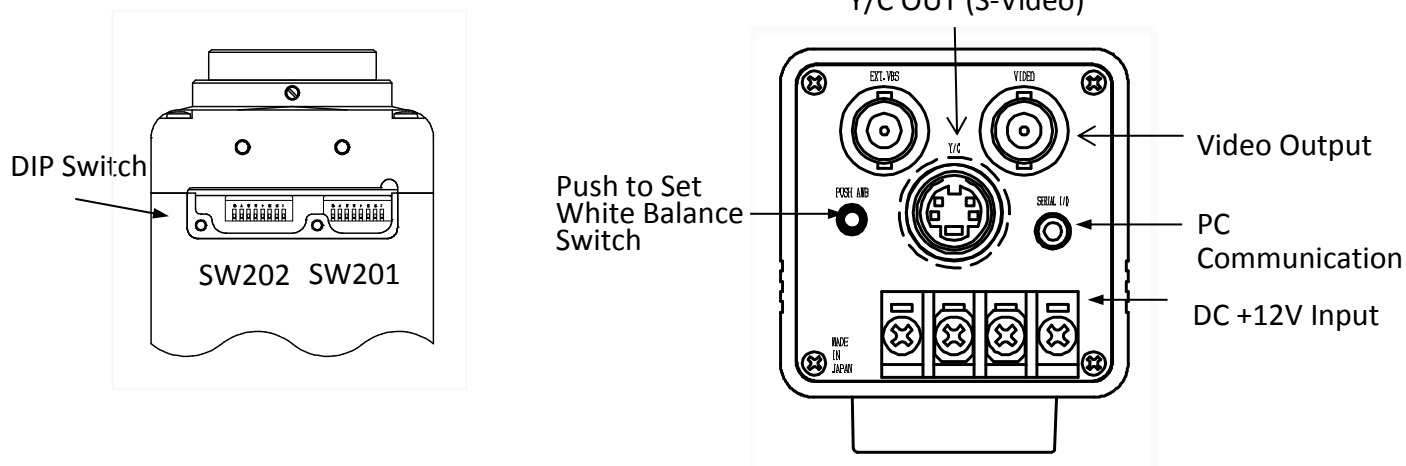

#### DC +12V Input

+12V Input DC 9V to15V  
Sentech Provided AC adapter : UN310-2P

#### Y/C OUT (S-Video)

Y/C Output

|       |                     |
|-------|---------------------|
| Pin 1 | Y OUT(1Vp-p 75Ω)    |
| Pin 2 | C OUT(300mVp-p 75Ω) |
| Pin 3 | GND(Y OUT)          |
| Pin 4 | GND(C OUT)          |

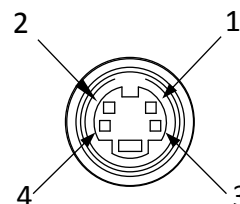

#### Video Output

BNC Connector (VBS 1.0Vp-p 75Ω)

#### External Sync(VBS)

BNC Connector, External Sync signal(VBS) input  
Internal/External Sync (automatic select)

#### PC Communication Terminal

Configurable through Control Software"TB D" in the CD-ROM with RS-232C cable(Stereo Pin-jack / D-Sub Pin9).

#### DIP Switch

Please refer to Section 1.1.2 "Switch Specifications"

## 4.2 Cased: PWJ Model

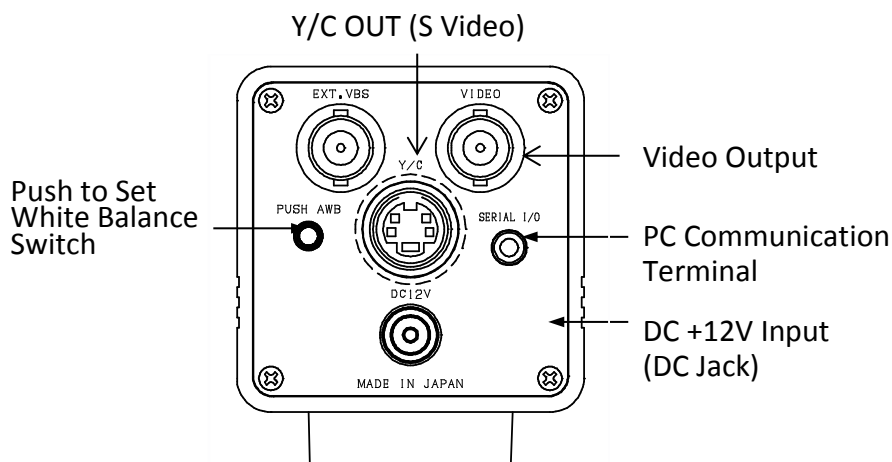
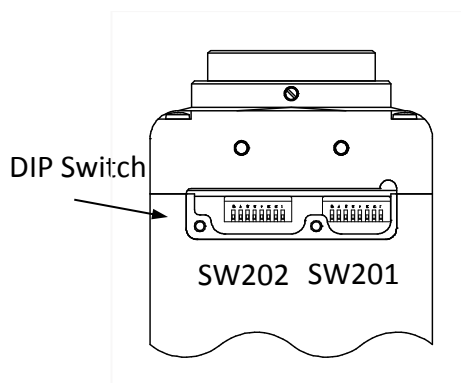

### Y/C OUT (S-Video)

### Y/C Output

|       |                     |
|-------|---------------------|
| Pin 1 | Y OUT(1Vp-p 75Ω)    |
| Pin 2 | C OUT(300mVp-p 75Ω) |
| Pin 3 | GND(Y OUT)          |
| Pin 4 | GND(C OUT)          |

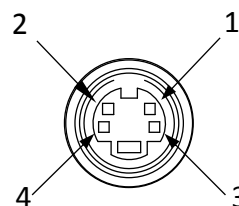

### DC +12V Input(DC Jack)

+12V DC Jack(Center Plus) DC9V to 15V  
Sentech Provided AC adapter : UN310-1210

### BNC Connector

Video Output (VBS 1.0Vp-p 75Ω)

### External Sync(VBS)

BNC Connector, External Sync signal(VBS) input  
Internal/External Sync (automatic select)

### PC Communication Terminal

Configurable through Control Software "TBD" in the CD-ROM with RS-232C cable (Stereo Pin-jack / D-Sub Pin9).

### DIP Switch

Please refer to Section 1.1.2 "Switch Specifications"

## 4.3 Cased: PWC Model

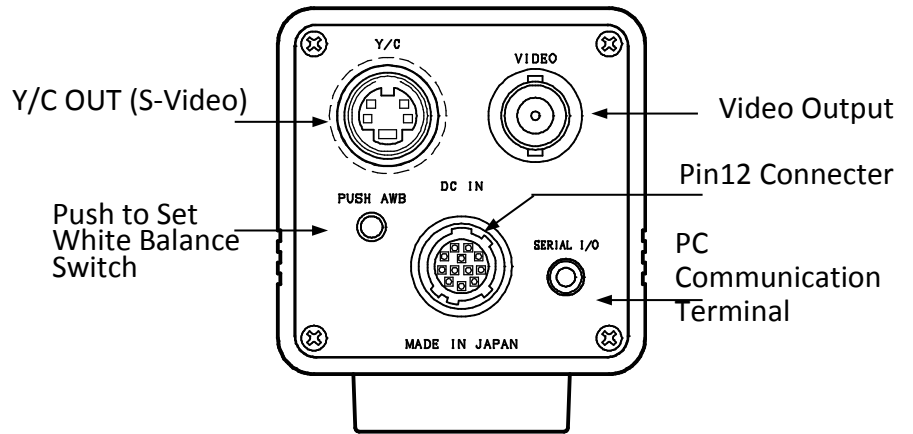
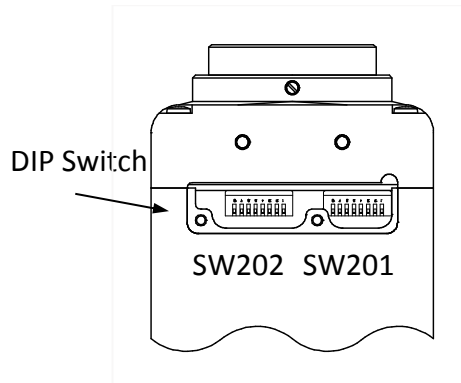

### Y/C OUT (S-Video)

### Y/C Output

|       |                     |
|-------|---------------------|
| Pin 1 | Y OUT(1Vp-p 75Ω)    |
| Pin 2 | C OUT(300mVp-p 75Ω) |
| Pin 3 | GND(Y OUT)          |
| Pin 4 | GND(C OUT)          |

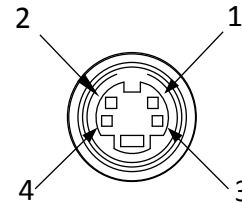

### Pin12 Connector

|        |        |
|--------|--------|
| Pin 1  | GND    |
| Pin 2  | +12V   |
| Pin 3  | GND    |
| Pin 4  | Y OUT  |
| Pin 5  | GND    |
| Pin 6  | EXT HD |
| Pin 7  | EXT VD |
| Pin 8  | GND    |
| Pin 9  | C OUT  |
| Pin 10 | GND    |
| Pin 11 | +12V   |
| Pin 12 | GND    |

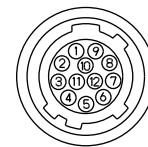

Connector : HR10A-10R-12PB (Hirose)

## External Sync HD/VD

|                  | NTSC(STC-620 Series)                                | NTSC(STC-630 Series)                                |
|------------------|---|---|
| Polarity         | Active Low, Falling Edge                            |   |
| External Sync    | Automatic detection                                 |   |
| HD               | HD signal(Pin6), HD GND(Pin5)                       |   |
| VD               | VD signal(Pin7), GND(Pin12)                         |   |
| Frequency        | HD 15.734kHz $\pm$ 50ppm,<br>VD 59.94Hz $\pm$ 50ppm | HD 15.625kHz $\pm$ 50ppm,<br>VD 50.00Hz $\pm$ 50ppm |
| HD, VD Amplitude | 3 to 5v   |   |
| impedance        | 2.3K ohm  |   |
| Width            | VD width: 9H(TYP), HD width 6 usec                  |   |

\*Power Input only

Sentech Provided AC adapter : UN310-12P

BNC Connector

Video Output (VBS 1.0Vp-p 75 $\Omega$ )

PC Communication Terminal

Configurable through Control Software" TBD" in the CD-ROM with RS-232C cable(Stereo Pin-jack / D-Sub Pin9).

DIP Switch

Please refer to Section 1.1.2 "Switch Specifications"

## 4.4 Board: P2,L2,CS2 Common Specifications

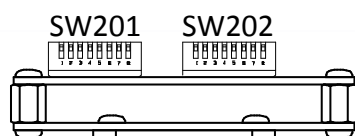

DIP Switch

Please refer to Section 1.1.2 "Switch Specifications"

CN PIN

Please refer to Section 1.1.2 "Switch Specifications"

## 5. Dimensions

### 5.1 Cased (C-Mount): PWT, PWJ, PWC

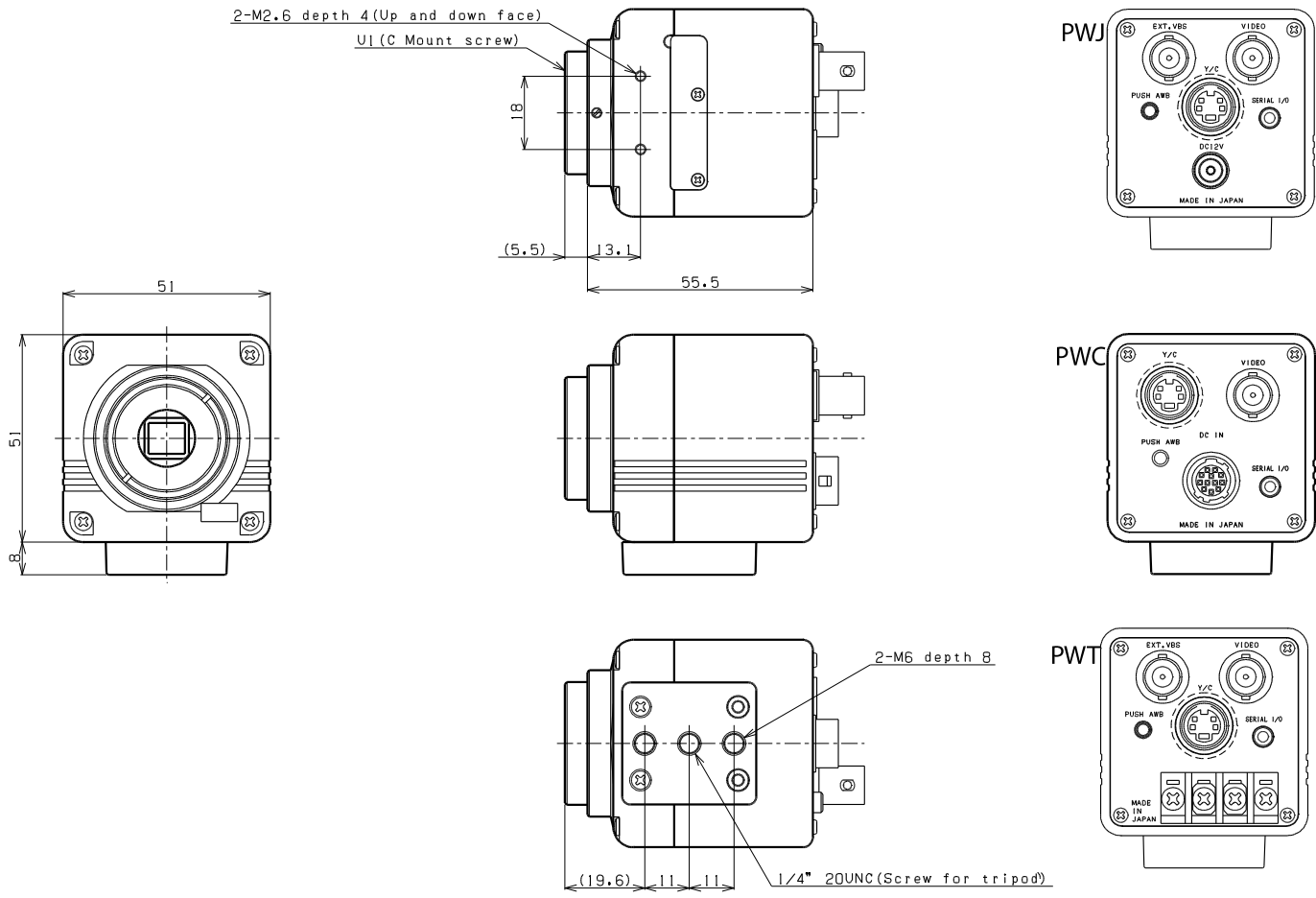

Unit: mm

## 5.2 Cased (CS-Mount): PWT, PWJ, PWC

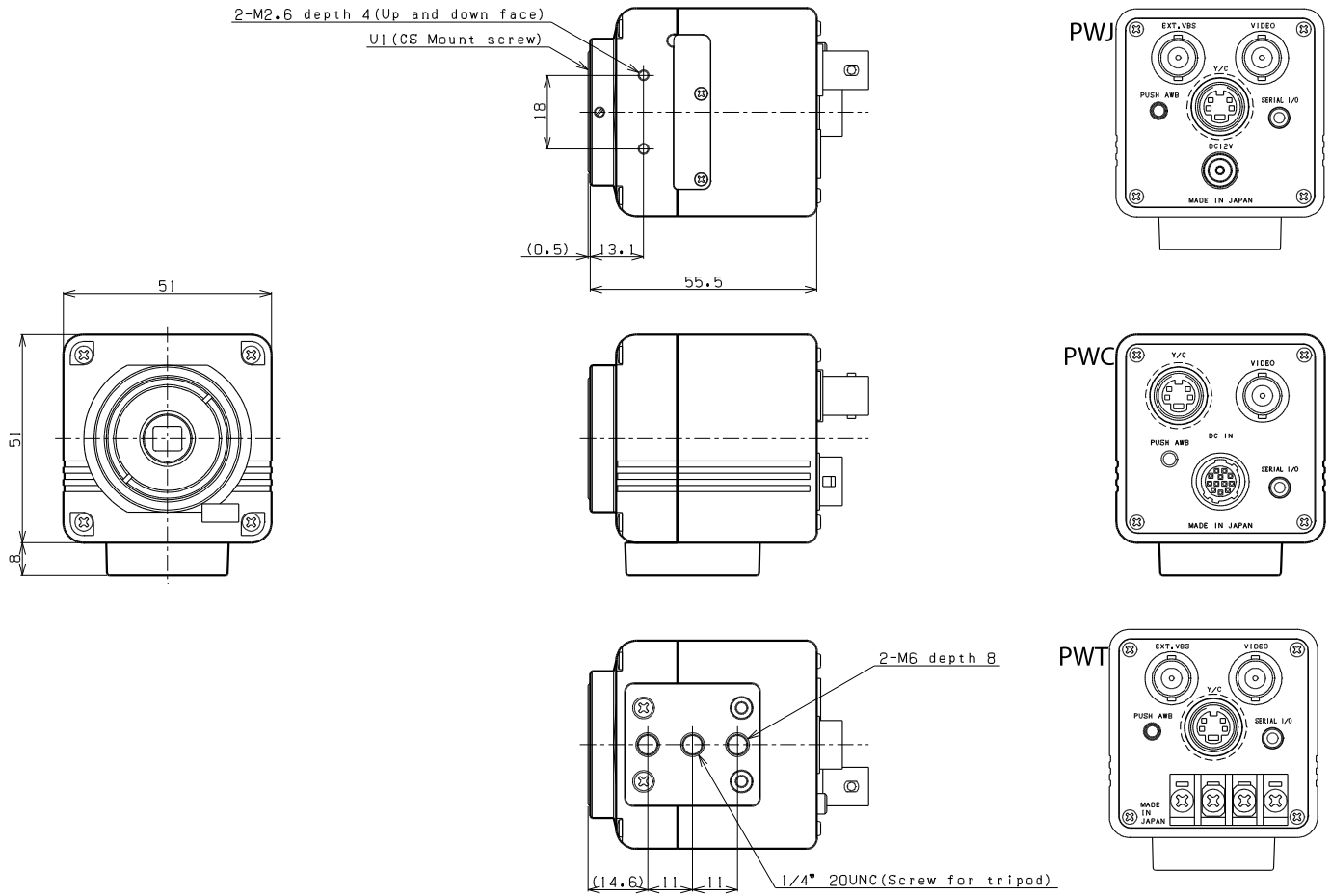

Unit: mm

## 5.3 Board: P2 Model

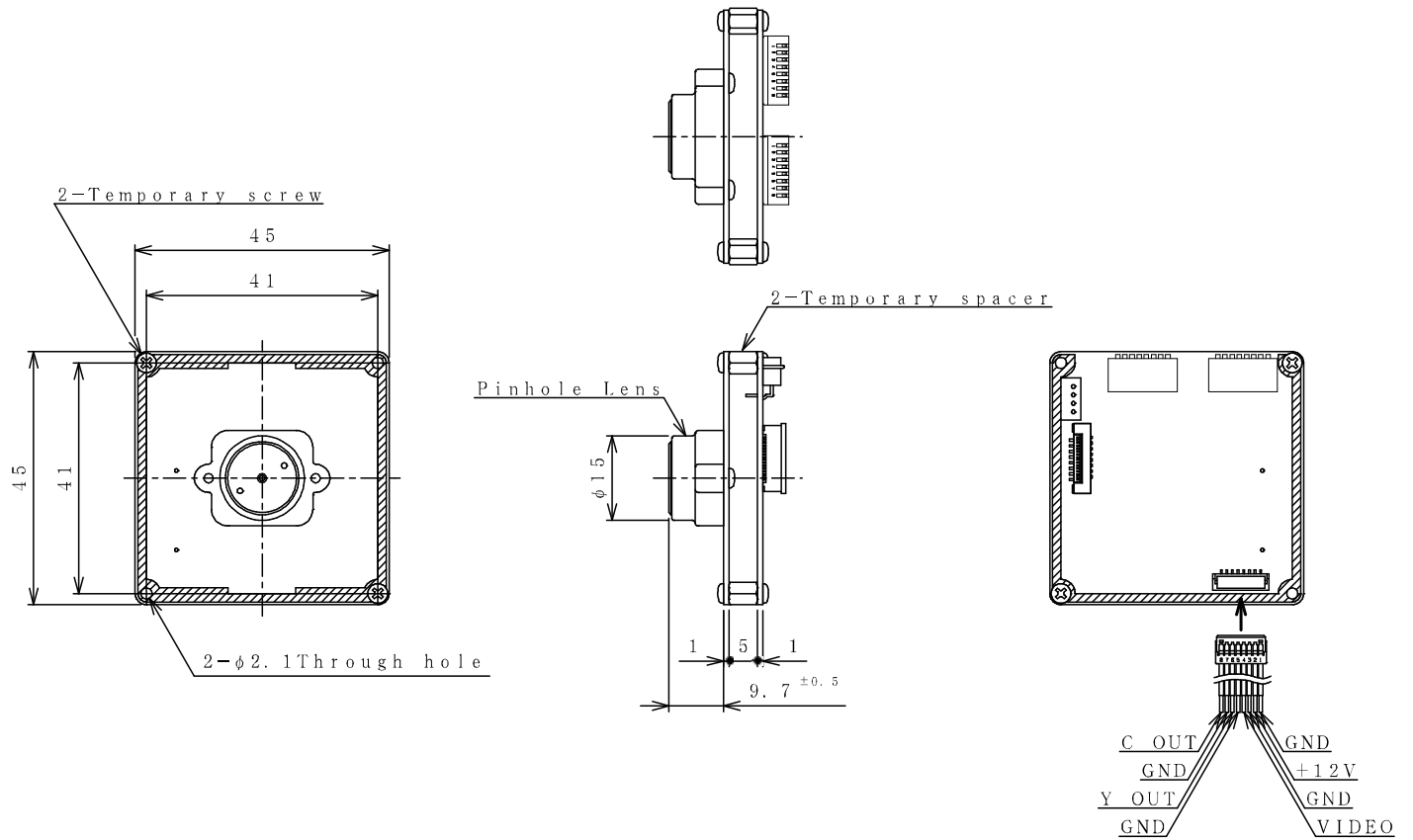

Unit: mm



## 5.4 Board: L2 Model

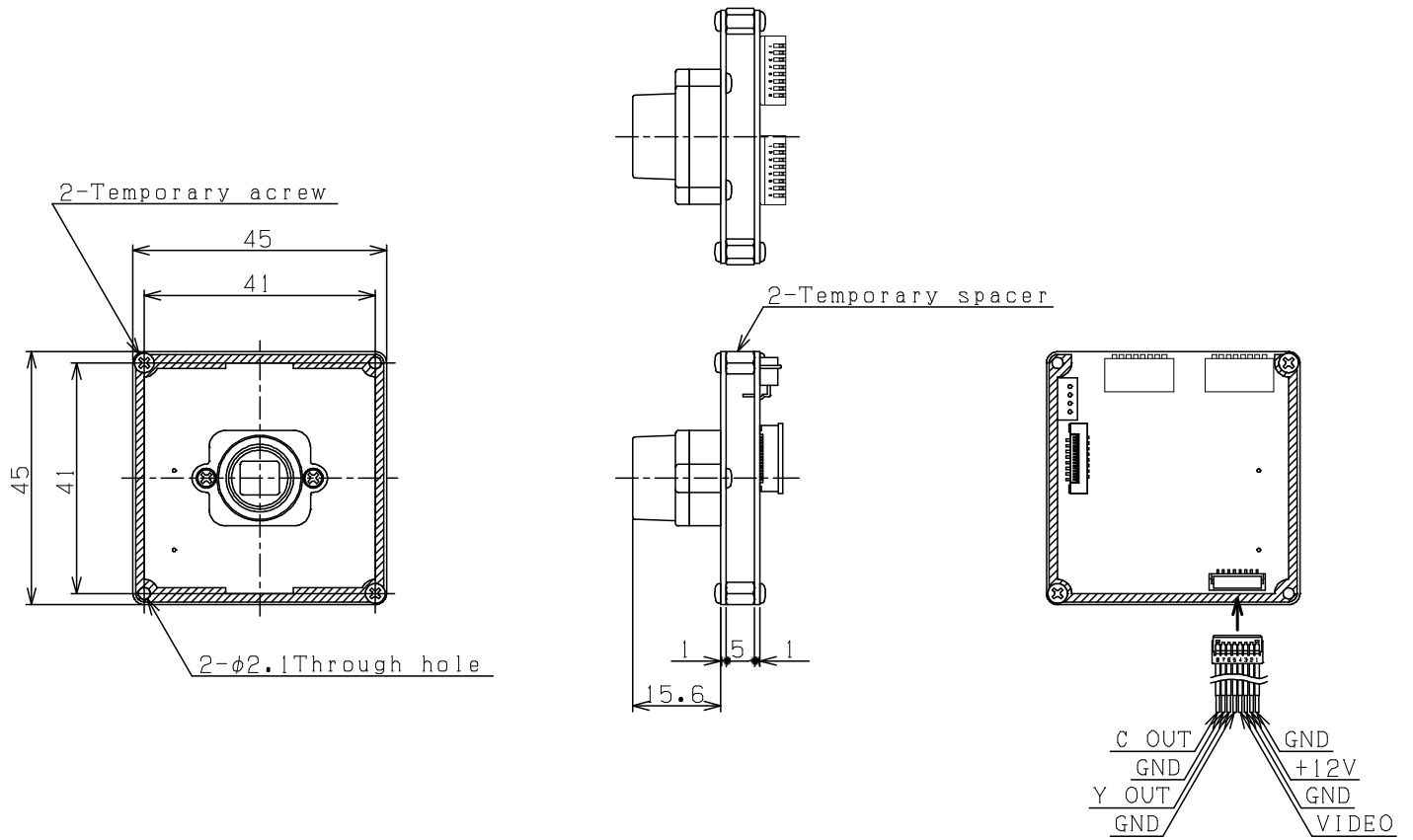

Unit: mm

## 5.5 Board: CS2 Model

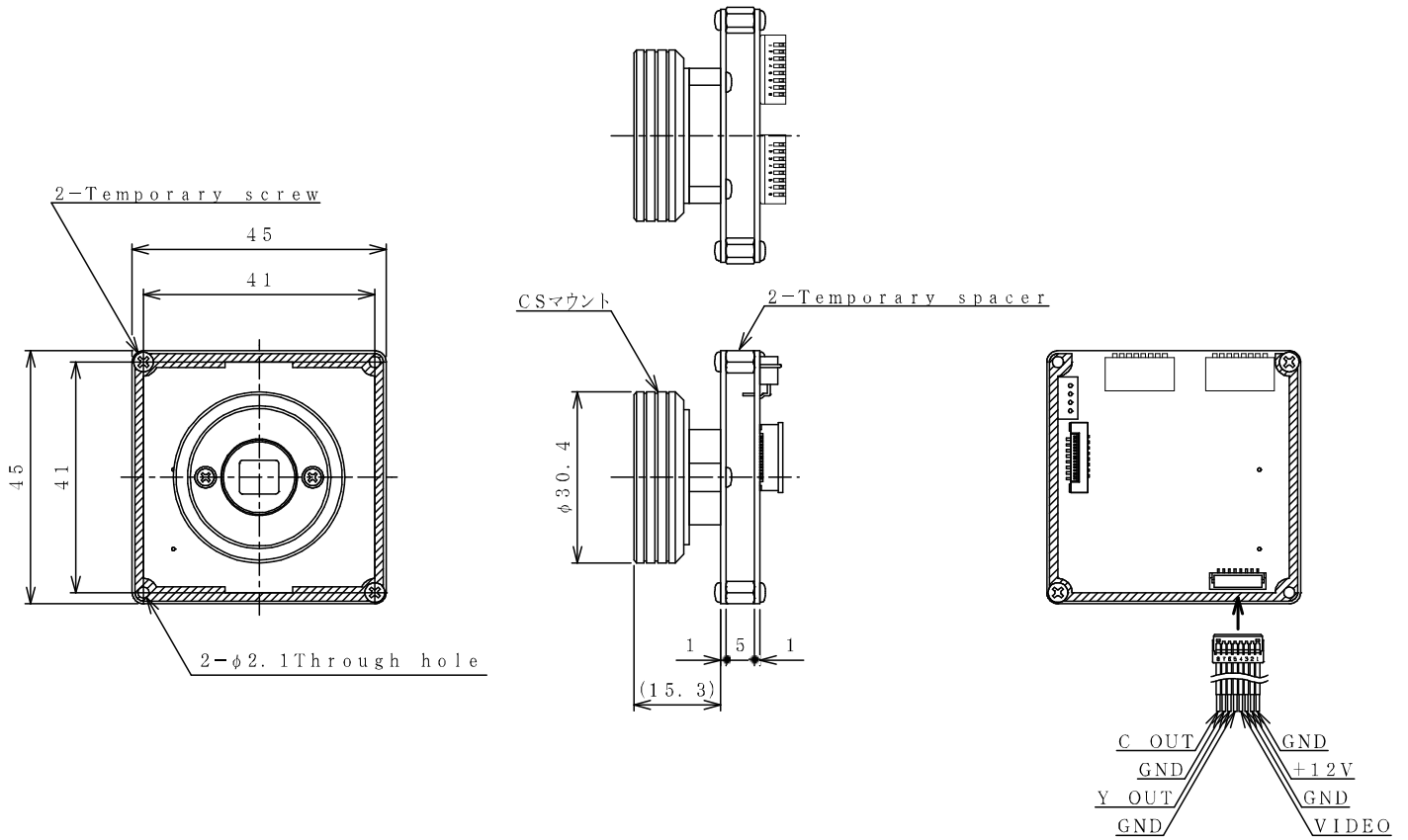

Unit: mm

## 6. Camera Set Up

When the user sets up the camera, the following items may be required:

- Model Number of the Camera
- DQUctrl – Control Software
- Communication Cable – Serial Pin Jack Cable (Serial Pin to RS232C Cable)
- Power: DC 12V

## 7. Communication Protocol Specifications and Control Software Manual

### 7.1 Communication Settings

| Setting      | Value      |
|--------------|------------|
| Baud rate    | 115,200bps |
| Data bit     | 8 bits     |
| Parity       | None       |
| Stop bit     | 2 bits     |
| Flow control | None       |

### 7.2 Communication Format

The format for sending / receiving data between the PC and the camera (DSP or FLASHROM) is show below:

#### 7.2.1 Specifications for the Commands Sent

| Function                        | 1Byte | 2Byte (COM) | 3Byte | 4Byte | 5Byte       | ----- | ----- |
|---------------------------------|-------|-------------|-------|-------|-------------|-------|-------|
| DSP register WRITE*             | SW    | 57h         | CAT   | STB   | DT0 --- DTn | CS    |       |
| DSP register READ               | SW    | 52h         | CAT   | STB   | ENB         | CS    |       |
| FLASHROM WRITE (ALL Categories) | SW    | 7Ah         | CS    |       |             |       |       |
| FLASHROM WRITE (1 Category)     | SW    | 79h         | CAT   | CS    |             |       |       |
| FLASHROM WRITE (Byte)           | SW    | 78h         | CAT   | STB   | ENB         | CS    |       |
| FLASHROM READ (Byte)            | SW    | 58h         | CAT   | STB   | ENB         | CS    |       |

\*The packet byte length varies depending on the length of the data strings (DT0 to DTn) to be written in the DSP registers.

The DSP registers data loads from the FLASH ROM when the camera is powered on. It is necessary to save data into the FLASH ROM to keep changing data even when the camera is powered off.

### DSP register WRITE (COM=57[h])

Write the Data into the DSP register on DT0 to DTn through the set Category and Start Byte.  
Maximum number of the registers that can be written with one packet is 58 bytes.

### DSP register READ (COM=52[h])

Read the Data from the DSP register on the Start Byte to End Byte through the set Category and Start Byte.  
Maximum number of the registers that can be read with one packet is 60 bytes.

### FLASHROM WRITE (ALL Categories) (COM=7A[h])

Write all of the current DSP register's data into the FLASH ROM.

### FLASHROM WRITE (1 Category) (COM=79[h])

Write the current DSP registers data on one specific category into the FLASH ROM.

### FLASHROM WRITE (Byte) (COM=78[h])

Write the current DSP register data from start byte to end byte on one specific category into the FLASH ROM.

### FLASHROM READ (COM=58[h])

Maximum number of data that can be read inside the FLASH ROM with one packet is 60 bytes.

#### <Abbreviation symbols>

|      |                |  |
|------|----------------|--|
| SW:  | Start Word     | Setting of the number of the valid bytes from SW and CS  |
| COM: | Command        | Setting of the commands and codes  |
| CS:  | Check Sum      | Setting of the check sum from SW to CS   |
| CAT: | Category       | Setting of the target category<br>Please check " <b>Error! Reference source not found.</b> " for the functions |
| STB: | Start Byte     | Setting of the start byte (any setting from 1[h] to FE[h] can be selected)                                     |
| ENB: | End Byte       | Setting of the end byte (any setting from 1[h] to FE[h] can be selected)                                       |
| DTn: | Data0 to Datan | Setting of the data to be written in the DSP register  |

#### # Examples:

DSP register write (Write the data 0x20 to address category 09,0x64):  
06,57,09,64,20,EA

06: 06 byte data  
57: DSP register write  
09: Category 09  
64: Start byte 0x64  
20: Write data 0x20  
EA: Check Sum

DSP register read (Read the data on address category 09 from 0x64 to 0x65):  
06,52,09,64,65,2A

06: 06 byte data  
52: DSP register read  
09: Category 09  
64: Start byte 0x64  
65: End byte 0x65  
2A: Check Sum

All categories data write into FLASH ROM:  
03,7A,7D

03: 03 byte data  
7A: All categories data write into FLASH ROM  
7D: Check Sum

One category data write into FLASH ROM (Write all of the data on category 09):  
04,79,09,86

04: 04 byte data  
79: One category data write into FLASH ROM  
09: Category 09  
86: Check Sum

## 7.2.2 Specification of the Data Received

| Function                           | 1Byte | 2Byte | 3Byte                  | ---- | ---- | ---- |
|------------------------------------|-------|-------|------------------------|------|------|------|
| DSP register WRITE                 | SW    | ST    | CS                     |      |      |      |
| DSP register READ                  | SW    | ST    | Read DT0 ---- Read DTn |      |      | CS   |
| FLASHROM WRITE<br>(ALL Categories) | SW    | ST    | CS                     |      |      |      |
| FLASHROM WRITE<br>(1 Category)     | SW    | ST    | CS                     |      |      |      |
| FLASHROM WRITE<br>(Byte)           | SW    | ST    | CS                     |      |      |      |
| FLASHROM READ<br>(Byte)*           | SW    | ST    | Read DT0 ---- Read DTn |      |      | CS   |

\* The packet byte length varies depending on the length of the data strings (DT0 to DTn) to be written in the DSP registers.

### <Abbreviation symbols>

|      |                |   |
|------|----------------|---|
| SW:  | Start Word     | The number of the valid bytes from SW and CS  |
| ST : | Status Word    | The result of the sent command<br><br>Successful completion: Number of bytes received previously<br>Unsuccessful completion: An error code<br><br>Error codes<br>F1[h]: Category number error<br>F2[h]: Byte number error<br>FE[h]: Check Sum error, Communication byte error |
| CS:  | Check Sum      | The check sum from SW to CS   |
| DTn: | Data0 to Datan | Read data   |

### #Example of Successful completion (DSP register WRITE)

Send: 0x06, 0x57, 0x09, 0x64, 0x20, 0xEA



6Byte  
Number of bytes  
received previously

06: 06 byte data  
57: DSP register WRITE  
09: Category 09  
64: Start byte 0x64  
65: Write data 0x20  
EA: Check Sum

Receive: 0x03, 0x06, 0x09

03: 03 byte data  
06: Number of bytes received  
previously  
09: Check Sum

## Detail of Error Codes

### 0xF1(Category number error)

When un-existing category is selected on Memory Write or Read command, this error code is output.

#### #Example

Send: 0x06, 0x52, 0x20, 0x01, 0x01, 0x7A

Receive: 0x03, 0xF1, 0xF4

0x20 is un-existing category. therefore ST return 0xF1.

### 0xF2(Byte number error)

When unavailable Start Byte or End Byte is selected on Memory Write or Read command, this error code is output.

#### #Example

Send: 0x06, 0x52, 0x03, 0xFE, 0xFE, 0x57

Receive: 0x03, 0xF2, 0xF5

0xFE is out of valuable rage of Start Byte on Category 03, 0xF2 is output.

### 0xF3(Communication format error)

When sending the command, the error on RS232C Communication format(like over run error, framing error) come up, this error code is output.

#### #Example

When 1StopBit was sent, even 2StopBit format is correct. This error code is output.

### 0xF4(Time out error)

When the number of valid bytes are not received within certain period, this error code is output.

## 7.3 Camera Control Command and Software Manual

This camera can be controlled through the communication protocol or the Control Software (DQUCtrl). When the user wants to access the function register directory, the user can refer to the sections below for address information.

### 7.3.1 Port Driver Function

The camera setting can be set through the External Switch (SW201,202). For further details, please refer to Section 1.1.2 Switch Specifications.

When the camera settings are changed through the External Switch (SW201,202), the Port Driver must be set to "ON". If the Port Driver is set to "OFF" then the settings will not be reflected.

However, when the camera settings are changed through the Control Software, the Port Driver should be set to "OFF" before the register is set. If the Port Driver is set to "ON", the settings will not be reflected.

#### Example:

The related register with Port Driver function is in the rectangular box on the Control Software (DQUCtrl)

|                                   |          |
|-----------------------------------|----------|
| Port Driver Function(SW202_4-PWB) | [02H]ON  |
| AWB Mode [C05_001H.0-3]           | [00H]ATW |

When Port Driver Function is "ON" External Switch (SW201, SW202) should be used. Under this condition, the AWB cannot be controlled through the Control Software.

|                                   |          |
|-----------------------------------|----------|
| Port Driver Function(SW202_4-PWB) | [02H]ON  |
| AWB Mode [C05_001H.0-3]           | [00H]ATW |

Port Driver Function : Disable for "ON"

If the user wishes to control AWB Mode through the Control Software, the Port Driver Function should be "OFF". However, when the Port Driver Function is "OFF", the External Switch's settings are disabled. Therefore AWB cannot be controlled through the External Switch.

|                                   |          |
|-----------------------------------|----------|
| Port Driver Function(SW202_4-PWB) | [00H]OFF |
| AWB Mode [C05_001H.0-3]           | [00H]ATW |

Port Driver Function : enable for "OFF"



## 7.3.2 Shutter / Gain



### Select AE Mode (AEMODE)

Selects the AE control mode

AE mode has to be set as “Auto exposure (AEME = 0 (0h))” to activate this mode selection. When the user sets this parameter through the DQUctrl, please turn off the Port Driver.

Category: 03d

Start byte: 002H.0-2

Condition: AEME = 0 (0h) (AE mode)

Setting: 0 (0h) to 2 (2h)

Selection:

- 0h: Shutter
- 1h: Reserved
- 2h: Shutter Fix

### Detailed description of AEMODE

SHTMAX, SHTMIN described in this section refer to the upper limit of the electronic shutter speed and the lower limit of the electronic shutter speed, respectively.

The upper limits of the electronic shutter speed are set using the SHTMAXML, SHTMAXL, SHTMAXH and SHTMAXM parameters.

The lower limits of the electronic shutter speed are set using the SHTMINML, SHTMINL, SHTMINH and SHTMINMH parameters.

For details on the electronic shutter speed range settings, refer to “AE minimum exposure time”

### AEMODE=0[h] Shutter

In this mode, auto exposure control is exercised in the middle-brightness and high-brightness areas using the electronic shutter. The electronic shutter speed is controlled across a range from SHTMIN and SHTMAX.

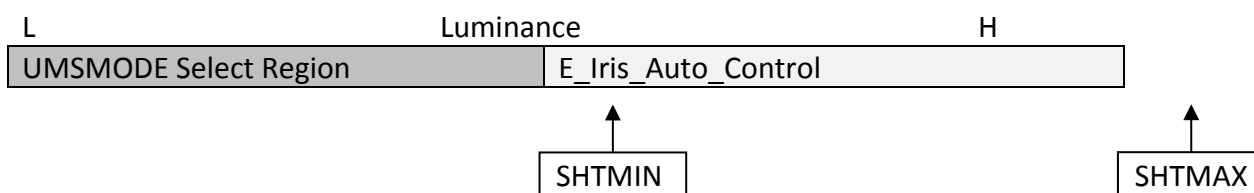

### AEMODE=2[h] Shutter Fix

In this mode, auto exposure control is exercised in the middle-brightness areas using the electronic shutter and in the high-brightness areas using the mechanical iris.

The electronic shutter speed is controlled across a range from SHTMIN and SHTMAX.

During electronic shutter control, the mechanical iris is fixed at open.

During mechanical iris control, SHTMAX serves as the electronic shutter value.

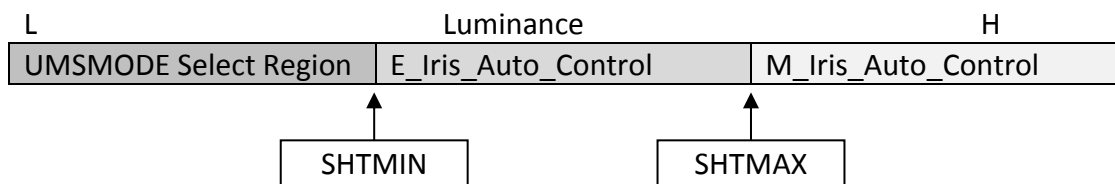

\* Use of a separate mechanical iris lens is required.

Example of use:

Set SHTMIN to 1/100[s] as a way of countering flicker in the low-brightness areas.

Normally, a setting of 1/60[s] (for NTSC) is used for switching between the electronic shutter and AGC area, but by setting the switching position to 1/100[s], it is possible to reduce the flicker in the AGC area.

Example of settings:

1/100[s] is set for SHTMIN, and 1/250[s] is set for SHTMAX.

### AEMODE=2[h] MIRIS(SHUTFIX) MODE

In this mode, the electronic shutter value is fixed, and auto exposure control is exercised over the middle-brightness and high-brightness areas using the mechanical iris.

The setting selected by ME is used as the electronic shutter value.

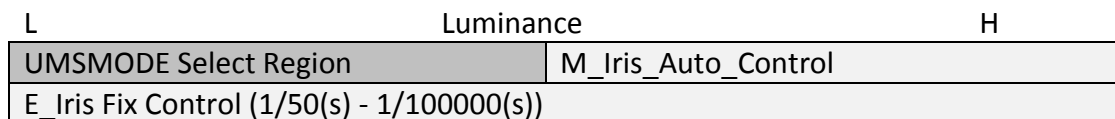

\*For the shutter value settings, refer to “ME control mode”.

\*In this mode, the shutter speed is always fixed so the low-speed shutter cannot be used at the same time.

To exercise mechanical iris control with the electronic shutter at a fixed setting and use low-speed shutter control at the same time, set SHUT + MIRIS MODE (AEMODE=1), and set SHTMIN and SHTMAX to the same value.

\*Use of a separate mechanical iris lens is required.

Example of use:

By allocating the shutter value setting parameters to the port drivers, the shutter speed can be changed using the rotary switches.

### AE User Reference Level (AEREFLVL)

When control is exercised using the mechanical iris and electronic shutter, AE operates so that the brightness is converged at the base reference position.

When the base reference is set high, the brightness converges at a high position; when it is set low, it converges at a low position.

Category: 03d

Start byte: 003H.0-004H.1

Condition: AEME = 0 (0h) (AE mode)

Setting: 0 (0h) to 1023 (3FFh)

## AE Speed (AESPEED)

The convergence speed of AE can be adjusted. If the convergence speed is too high, AE may oscillate near the convergence position. The AE oscillation can be prevented by adjusting the convergence speed.

The higher the AESPEED parameter setting, the lower the convergence speed; conversely, the lower the parameter setting, the higher the speed.

Sets the AE convergence speed

### AE Base Reference Level

AE mode has to be set as "Auto exposure (AEME = 0 (0h))" to activate this AE convergence speed setting

Category: 03 d

Start byte: 009H.0-7

Condition: AEME = 0 (0h) (AE mode)

Setting: 0 (0h) to 255 (FFh)

Selection:

0[h] (fast) to FF[h] (slow)

## AE Dead Band (AEDBAND)

The dead bands are provided to ensure that AE will not track the very minor changes in the brightness. AE operates only when the brightness has changed from the convergence level by an amount exceeding the values set by the dead bands.

The dead bands are adjusted by the following parameters, and can be adjusted only for the AGC control area and the low-speed shutter area. Increasing the value widens the dead band, and makes it more difficult for AE to follow changes in the brightness.

Sets the dead bands for the AGC control area and the low-speed shutter area

AE mode has to be set as "Auto exposure (AEME = 0 (0h))" to activate this AE dead band adjustment setting

Category: 03 d

Start byte: 00BH.0-7

Condition: AEME = 0 (0h) (AE mode)

Setting: 0 (0h) to 255 (FFh)

Selection:

0[h] (no dead band) to FF[h] (maximum dead band)

High-Speed Shutter

|   |                       |   |
|---|-----------------------|---|
| High-speed shutter MAX value (1/10s Unit) [C03_00DH.0-3]    | <input type="range"/> | <input type="text" value="0"/>            |
| High-speed shutter MAX value (1/100s Unit) [C03_00DH.4-7]   | <input type="range"/> | <input type="text" value="0"/>            |
| High-speed shutter MAX value (1/1000s Unit) [C03_00EH.0-3]  | <input type="range"/> | <input type="text" value="0"/>            |
| High-speed shutter MAX value (1/10000s Unit) [C03_00EH.4-7] | <input type="range"/> | <input type="text" value="10"/>           |
|   |                       | <input type="text" value="1/100,000[s]"/> |
| High-speed shutter MIN value (1/10s Unit) [C03_00FH.0-3]    | <input type="range"/> | <input type="text" value="0"/>            |
| High-speed shutter MIN value (1/100s Unit) [C03_00FH.4-7]   | <input type="range"/> | <input type="text" value="0"/>            |
| High-speed shutter MIN value (1/1000s Unit) [C03_010H.0-3]  | <input type="range"/> | <input type="text" value="0"/>            |
| High-speed shutter MIN value (1/10000s Unit) [C03_010H.4-7] | <input type="range"/> | <input type="text" value="0"/>            |
|   |                       | <input type="text" value="1/60[s]"/>      |

## AE minimum exposure time

Sets the minimum exposure time for the auto exposure control

AE mode has to be set as “Auto exposure (AEME = 0 (0h))” to activate this AE minimum exposure time setting

SHTMAXML : High-speed shutter MAX value (1/10s Unit)

SHTMAXL : High-speed shutter MAX value (1/100s Unit)

SHTMAXH : High-speed shutter MAX value (1/1000s Unit)

SHTMAXMH : High-speed shutter MAX value (1/10000s Unit)

|            | SHTMAXML  | SHTMAXL                                    | SHTMAXH                                     | SHTMAXMH                                     |
|------------|---|--|---|--|
| Outline    | The minimum exposure time for the auto exposure control |  |   |  |
| Category   | 03 d  |  |   |  |
| Start byte | 00DH.0-3  | 00DH.4-7                                   | 00EH..0-3                                   | 00EH..4-7                                    |
| Setting    | 0 (0h) to 9 (9h)  | 0 (0h) to 9 (9h)                           | 0 (0h) to 9 (9h)                            | 0 (0h) to 10 (Ah)                            |
| Selection  | Sets the denominator of the 1/10[s] digit               | Sets the denominator of the 1/100[s] digit | Sets the denominator of the 1/1000[s] digit | Sets the denominator of the 1/10000[s] digit |

Sets the minimum exposure time as 1/100,000 seconds

Category: 03d

Start byte: 13d.0

Condition: AEME = 0 (0h) (AE mode), AEMODE = 0, 1(h)

Setting: 000A

## AE maximum exposure time

Sets the maximum exposure time for the auto exposure control

AE mode has to be set as “Auto exposure (AEME = 0 (0h))” to activate this AE maximum exposure time setting

SHTMINML : High-speed shutter MIN value (1/10s Unit)

SHTMINL : High-speed shutter MIN value (1/100s Unit)

SHTMINH : High-speed shutter MIN value (1/1000s Unit)

SHTMINMH : High-speed shutter MIN value (1/10000s Unit)

|            | SHTMINML  | SHTMINL                                    | SHTMINH                                     | SHTMINMH                                     |
|------------|---|--|---|--|
| Outline    | The maximum exposure time for the auto exposure control |  |   |  |
| Category   | 03 d  |  |   |  |
| Start byte | 00FH..0-3   | 00FH..4-7                                  | 010H.0-3                                    | 010H.4-7                                     |
| Setting    | 0 (0h) to 9 (9h)  | 0 (0h) to 9 (9h)                           | 0 (0h) to 9 (9h)                            | 0 (0h) to 10 (Ah)                            |
| Selection  | Sets the denominator of the 1/10[s] digit               | Sets the denominator of the 1/100[s] digit | Sets the denominator of the 1/1000[s] digit | Sets the denominator of the 1/10000[s] digit |

To sets the maximum exposure time as 1/100,000 seconds

Category: 03d

Start byte: 15d.0

Condition: AEME = 0 (0h) (AE mode), AEMODE = 0, 1(h)

Setting: 000A

### # Examples:

Set the shutter speed to 1/250[s].

SHTMAXML → 5 (1/10s digit)    SHTMINML → 5 (1/10s digit)

SHTMAXL → 2 (1/100s digit)    SHTMINL → 2 (1/100s digit)

SHTMAXH → 0 (1/1,000s digit)    SHTMINH → 0 (1/1,000s digit)

SHTMAXMH → 0 (1/10,000s digit)    SHTMINMH → 0 (1/10,000s digit)

## Under MinShutter Mode (UMSMODE)

Selects the AE control mode (low-brightness areas)

AE mode has to be set as “Auto exposure (AEME = 0 (0h))” to activate this AE control mode selection for the low brightness areas

Category: 03 d

Start byte: 002H.3-5

Condition: AEME = 0 (0h) (AE mode), Port Driver Function (SW202.1-3) = “ON”

Setting: 0 (0h) to 5 (5h)

Selection:

- 0h: UMSSOFF
- 1h: AGC Mode
- 2h: SLOW Shutter Mode
- 3h: AGC -> SLOW Shutter
- 4h: SLOW Shutter -> AGC
- 5h: AGC -> SLOW Shutter -> AGC

### Detailed description of UMSMODE

One of the following six modes for UMSMODE (under min. shutter modes) can be selected as the control method under low-brightness conditions where the sufficient exposure cannot be achieved using the electronic shutter or mechanical iris.

### UMSMODE=0[h] UMSSOFF MODE

In this mode, no exposure control is exercised in the low-brightness areas.

AGC is fixed at the gain value which was set using the AGCMIN parameter (CAT9\_Byte80\_bit0-7).

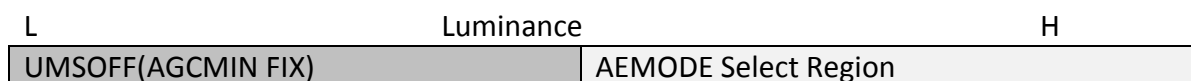

### UMSMODE=1[h] AGC MODE

In this mode, auto exposure control is exercised over the low-brightness areas using AGC. The control range for AGC is set using the AGCMIN and AGCMAXL.

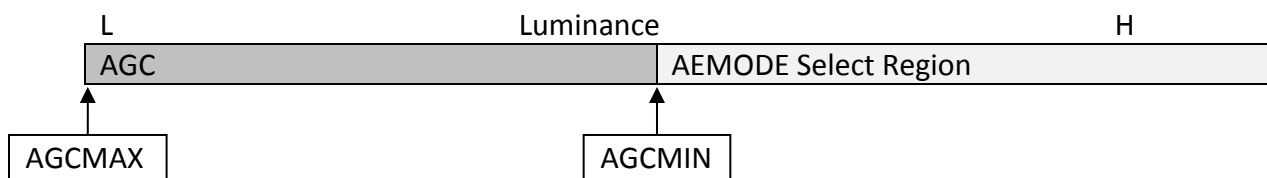



### UMSMODE=2[h] SLOW Shutter MODE

In this mode, auto exposure control is exercised in the low-brightness areas using the low-speed shutter. The maximum storage time is set using SLOWMAX. This time can be set in 1-field increments, and a maximum of 512 fields can be stored.

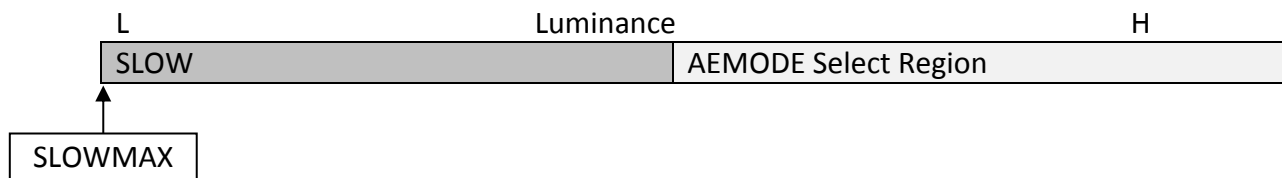

### UMSMODE=3[h] AGC -> SLOW Shutter MODE

In this mode, auto exposure control is exercised in the low-brightness areas using AGC and the low-speed shutter. When a low-brightness area is entered from a middle-brightness area, AGC control is exercised first. When the gain value of AGC reaches its maximum, operation transfers to low-speed shutter control. The control range for AGC is set using the AGCMIN and AGCMAXL parameters. The maximum storage time of the low-speed shutter is set using SLOWMAX. The AGCMAX value serves as the AGC gain value in the low-speed shutter control area.

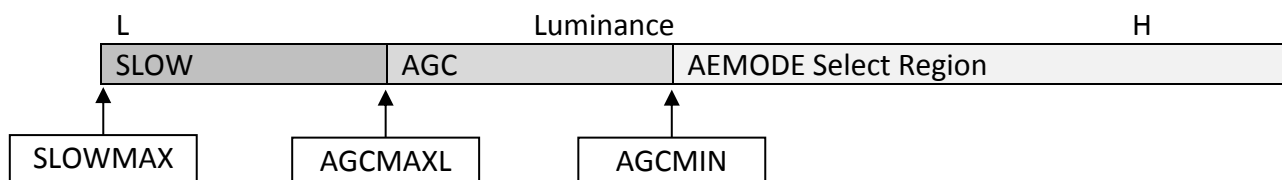

### UMSMODE=4[h] SLOW Shutter -> AGC MODE

In this mode, auto exposure control is exercised in the low-brightness areas using the low-speed shutter and AGC. When a low-brightness area is entered from a middle-brightness area, low-speed shutter control is exercised first. When the storage time of the low-speed shutter reaches its maximum, operation transfers to AGC control. The maximum storage time of the low-speed shutter is set using SLOWMAX. The control range for AGC is set using the AGCMIN and AGCMAXL parameters. The SLOWMAX value serves as the electronic shutter value in the AGC control area.

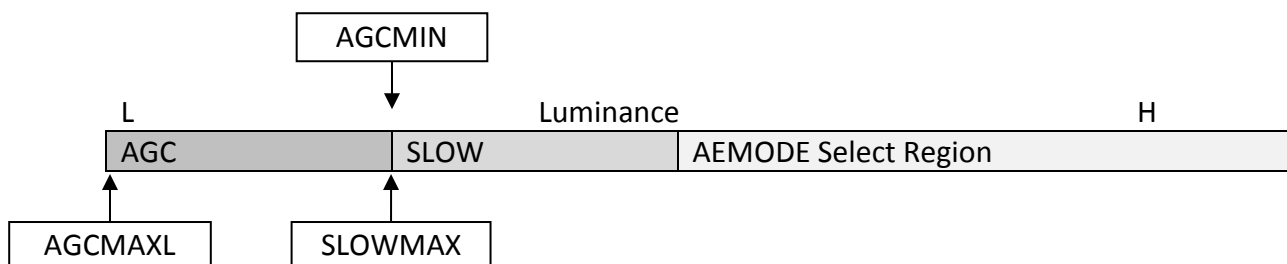

## UMSMODE=5[h] AGC -> SLOW Shutter -> AGC MODE

In this mode, the signal-to-noise ratio and dynamic resolution can be adjusted by dividing the low-brightness areas into three control areas and by inserting the low-speed shutter area inside the AGC area. When a low-brightness area is entered from a middle-brightness area, AGC control is exercised first. When the gain value of AGCMID is reached, operation transfers to low-speed shutter control. Then, when the storage time of the low-speed shutter reaches its maximum, operation returns to AGC control. The AGC control range is set using the AGCMIN, AGCMID and AGCMAXL parameters. The maximum storage time of the low-speed shutter is set using SLOWMAX. The value which was set by AGCMID serves as the AGC gain value in the low-speed shutter control area. The value which was set by SLOWMAX serves as the shutter value in the AGC control area after low-speed shutter control.

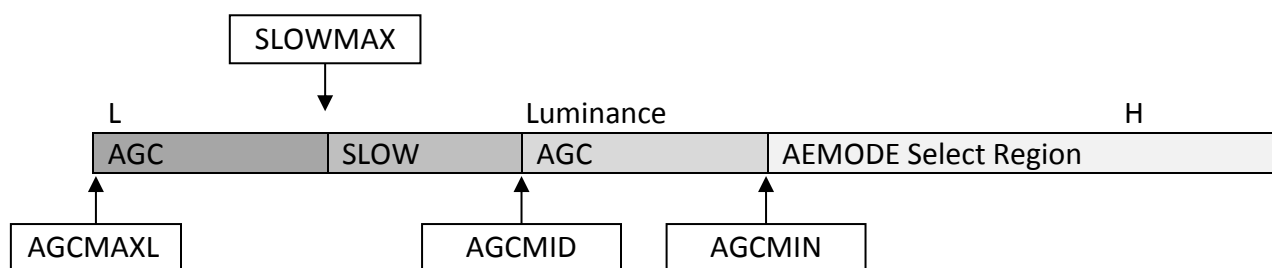

\*Set the maximum value (AGCMAXL), minimum value (AGCMIN) and boundary value (AGCMID) of the AGC gain in such a way that all three values stand in the proper correlation to one another. (AGCMAXL > AGCMID > AGCMIN)

Low-speed shutter control is exercised within the predetermined range of the number of storage fields. The upper limit of the number of storage fields can be set as desired.

### Slow Shutter Max Accumulation Time (SLOWMAX)

Sets the upper limit of the number of low-speed shutter storage fields

Category: 03 d

Start byte: 015H.1-016H.1

Condition: AEME = 0 (0h) (AE mode), UMSMODE = 2,3,4,5(h)

Setting: 0 (0h) to 511 (1FFh)

Selection:

The upper limit of the number of storage fields can be set in the 1 to 512 range.

Number of storage fields [FLD] = Setting + 1

## AGC MAX Gain (AGCMAXL)

Sets the maximum gain for the AGC control

The maximum gain for the AGC control has to be greater than the boundary value of the AGC gain.

Category: 03 d

Start byte: 012H.0-7

Condition: AEME = 0 (0h), UMSMODE=1,3,4,5(h),

Setting: 0 (0h) to 255 (FFh)

Selection:

00 - FF[h]

\*Note: configurable value depends on camera model.

## AGC MID Gain (AGCMID)

Sets the boundary value of the AGC gain.

The boundary value of the AGC gain has to be smaller than the maximum gain and the greater than the minimum gain for the AGC control.

Category: 03 d

Start byte: 014H.0-7

Condition: UMSMODE = 5 (5h) , AGCMAXL > AGCMID > AGCMIN

Setting: 0 (0h) to 255 (FFh)

Selection:

00 - FF[h]

\*Note: configurable value depends on camera model.

## AGC MIN Gain (AGCMIN)

Sets the minimum gain for the AGC control

The minimum gain for the AGC control has to be smaller than the boundary value of the AGC gain.

Category: 09 d

Start byte: 050H.0-7

Condition: -

Setting: 0 (0h, low gain) to 255 (FFh, high gain)

Selection:

00 - FF[h]: Low gain - High gain

\*Note: configurable value depends on camera model.

## 7.3.3 Chroma

High Luminance Chroma Suppress

High Luminance Chroma Suppress Selection [C02\_03DH.2] [01H]ON

High Luminance Chroma Suppress Threshold [C02\_03DH.3-03EH.4] 544

High Luminance Chroma Suppress Step Width [C02\_03EH.5-03FH.0] 1

### High Luminance Chroma Suppress Selection(CSHLON)

Sets the high-brightness chroma suppression function to ON or OFF.

Category: 02 d

Start byte: 03DH.2

Condition: -

Selection:

0[h] : OFF

1[h] : ON

### High Luminance Chroma Suppress Threshold

Sets the high-brightness chroma suppression brightness threshold.

Category: 02 d

Start byte: 03DH.3-03EH.4

Condition: -

Setting: 000 (0h) to 1023 (3FFh) (low to high)

### High Luminance Chroma Suppress Step Width (CSHLSTEP)

Sets the high-brightness chroma suppression step width 0[h] to F[h] (sharp to smooth)

Category: 02 d

Start byte: 03EH.5-03FH.0

Condition: -

Setting: 0 (0h) to 15 (Fh) (sharp to smooth)

Low Luminance Chroma Suppress

Low Luminance Chroma Suppress Selection [C02\_03FH.1] [01H]ON

Low Luminance Chroma Suppress Threshold [C02\_03FH.2-040H.3] 26

Low Luminance Chroma Suppress Step Width [C02\_040H.4-7] 1

## Low Luminance Chroma Suppress Selection(CSLLON)

Sets the low-brightness chroma suppression function to ON or OFF.

Category: 02 d

Start byte: 03FH.1

Condition: -

Selection:

0[h] : OFF

1[h] : ON

## Low Luminance Chroma Suppress Threshold(CSLLTH)

Sets the low-brightness chroma suppression brightness threshold.

Category: 02 d

Start byte: 03FH.2 - 040H.3

Condition: -

Setting: 0 (0h) to 1023 (3FFh) (low to high)

## Low Luminance Chroma Suppress Step Width(CSLLSTEP)

Sets the low-brightness chroma suppression function to ON or OFF.

Category: 02 d

Start byte: 040H.4-7

Condition: -

Setting: 0 (0h) to 15 (Fh) (sharp to smooth)

Hue/Gain

4Quadrant Setting [C02\_035H.0] [01H]Separate Setting

|  |  |     |        |
|--|--|-----|--------|
| R-Y GAIN 1st Quadrant Limit [C02_041H] |  | 160 | 0.627  |
| B-Y GAIN 1st Quadrant Limit [C02_045H] |  | 160 | 0.627  |
| R-Y HUE 1st Quadrant Limit [C02_049H]  |  | -32 | -0.125 |
| B-Y HUE 1st Quadrant Limit [C02_04DH]  |  | -12 | -0.047 |
| R-Y GAIN 2nd Quadrant Limit [C02_042H] |  | 160 | 0.627  |
| B-Y GAIN 2nd Quadrant Limit [C02_046H] |  | 160 | 0.627  |
| R-Y HUE 2nd Quadrant Limit [C02_04AH]  |  | -32 | -0.125 |
| B-Y HUE 2nd Quadrant Limit [C02_04EH]  |  | -12 | -0.047 |
| R-Y GAIN 3rd Quadrant Limit [C02_043H] |  | 144 | 0.565  |
| B-Y GAIN 3rd Quadrant Limit [C02_047H] |  | 160 | 0.627  |
| R-Y HUE 3rd Quadrant Limit [C02_04BH]  |  | -32 | -0.125 |
| B-Y HUE 3rd Quadrant Limit [C02_04FH]  |  | -12 | -0.047 |
| R-Y GAIN 4th Quadrant Limit [C02_044H] |  | 144 | 0.565  |
| B-Y GAIN 4th Quadrant Limit [C02_048H] |  | 160 | 0.627  |
| R-Y HUE 4th Quadrant Limit [C02_04CH]  |  | -32 | -0.125 |
| B-Y HUE 4th Quadrant Limit [C02_050H]  |  | -12 | -0.047 |

## 4Quadrant Setting(CNEGPOS)

Chroma signal negative/positive reversal function.

Category: 02 d

Start byte: 040H.4-7

Condition: -

Setting: 0 (0h) to 1 (1h)

0[h] : Simultaneous Setting 1[h] : Separate Setting

## R-Y GAIN Quadrant Limit

Users can use the hue and gain adjustments to adjust the colors to their preference by setting the color gain parameters (RYGAIN0-4, BYGAIN0-4) and phase parameters (RYHUE0-4, BYHUE0-4). There are two setting options: the 4-quadrant simultaneous setting which is used to adjust all four quadrants using only the parameters of the first quadrant, and the 4-quadrant separate setting which is used to adjust each of the four quadrants separately. The 4-quadrant separate setting enables color adjustments with a greater degree of freedom.

| Parameter                                     | Address                                   | Description                               |
|---|---|---|
| R-Y GAIN 1st to 4th Quadrant Limit(RYGAIN0-4) | Category: 02 d<br>Start byte: 041H - 04FH | Adjusts the R-Y GAIN in quadrants 1 to 4. |
| R-Y GAIN 1st to 4th Quadrant Limit(BYGAIN0-4) |   | Adjusts the B-Y GAIN in quadrants 1 to 4. |
| R-Y Hue1st to 4th Quadrant Limit(RYHUE0-4)    |   | Adjusts the R-Y Hue in quadrants 1 to 4.  |
| B-Y Hue 1st to 4th Quadrant Limit(BYHUE0-4)   |   | Adjusts the B-Y Hue in quadrants 1 to 4.  |

\*Note: Be very careful with the settings when setting the HUE and GAIN to be adjusted separately for the four quadrants since problems may occur in the color reproduction along with the boundaries between the quadrants if considerably different gain and hue are established for each quadrant.

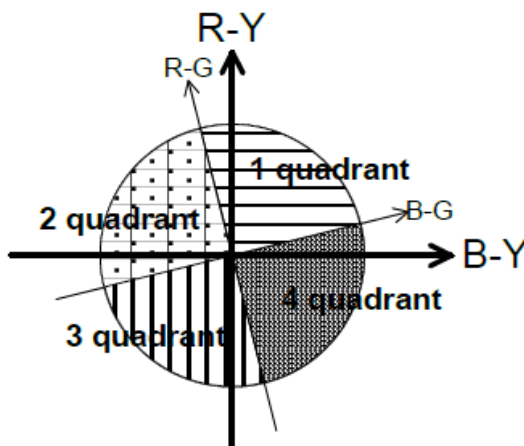

## 7.3.4 Gamma

### Gamma Function Mode(GAMMAMODE)

Sets the Y variable gamma

Category: 02 d

Start byte: 00DH.0

Condition: -

Setting: 0 (0h) to 1 (1h)

Selection:

0h: Manual

1h: Preset Mode

### Y Gamma level (YGAM)

Sets the Y variable gamma. This DSP value describes the reciprocal value, the Gamma value should be reciprocal.

Category: 02 d

Start byte: 00DH..4-7

Condition: GAMMAMODE = 1

Setting: 0 (0h) to 8 (8h)

Selection:

0h: Gamma = 1.2 (Gamma=0.83)

1h: Gamma = 1.4 (Gamma=0.71)

2h: Gamma = 1.6 (Gamma=0.62)

3h: Gamma = 1.8 (Gamma=0.55)

4h: Gamma = 2.0 (Gamma=0.50)

5h: Gamma = 2.2 (Gamma=0.45)

6h: Gamma = 2.4 (Gamma=0.41)

7h: Gamma = 2.6 (Gamma=0.38)

8h: Gamma = 1.0 (Gamma=1.00)



## Y Kneel level (YKNEE)

Set the Y variable kneel

Category: 02 d

Start byte: 00EH.0-3

Condition: GAMMAMODE = 1

Setting: 0 (0h) to 8 (8h)

Selection:

0h: 104%

1h: 106%

2h: 108%

3h: 110%

4h: 112%

5h: 114%

6h: 116%

7h: 118%

8h: Max output signal

The low brightness side with an output level up to 100% is the Y gamma area. The gamma curve has an increasingly higher output level as the YGAM preset value is increased from 0[h] to 7[h]. A setting of 8[h] selected for the YGAM produces gamma characteristics where the input and output levels up to 100% are connected in a straight line. The high-brightness side with input and output levels in excess of 100% is the Y knee area. The gradient of the knee characteristics becomes increasingly lower as the YKNEE preset value is decreased from 7[h] to 0[h].

## Chroma Gamma level (CGAM)

Set the C variable gamma

Category: 02 d

Start byte: 14 d.4-7

Condition: GAMMAMODE = 1

Setting: 0 (0h) to 8 (8h)

Selection:

0h: Gamma = 1.2 (Gamma = 0.83)

1h: Gamma = 1.4 (Gamma = 0.71)

2h: Gamma = 1.6 (Gamma = 0.62)

3h: Gamma = 1.8 (Gamma = 0.55)

4h: Gamma = 2.0 (Gamma = 0.50)

5h: Gamma = 2.2 (Gamma = 0.45)

6h: Gamma = 2.4 (Gamma = 0.41)

7h: Gamma = 2.6 (Gamma = 0.38)

8h: Gamma = 1.0 (Gamma = 1.00)

## Chroma Knee level (CKNEE)

Set the C variable knee

Category: 02 d

Start byte: 15 d.0-3

Condition: GAMMAMODE = 1

Setting: 0 (0h) to 8 (8h)

Selection:

0h: 104%

1h: 106%

2h: 108%

3h: 110%

4h: 112%

5h: 114%

6h: 116%

7h: 118%

8h: Max output signal

Any chroma gamma and knee level can be set by combining one of nine chroma gamma curves using CGAM with one of nine chroma knee levels using CKNEE.

The low-range side with an output level up to 100% is the chroma gamma area. The gamma curve has an increasingly higher output level as the CGAM preset value is increased from 0[h] to 7[h]. A setting of 8[h] selected for CGAM produces gamma characteristics where the input and output levels up to 100% are connected by a straight line.

The high-range side with input and output levels in excess of 100% is the chroma knee area. The gradient of the knee characteristics becomes increasingly lower as the CKNEE preset value is decreased from 8[h] to 1[h].

A setting of 0[h] selected for CKNEE produces knee characteristics which connect a level up to the maximum

### 7.3.5 BLC (Back Light Compensation)

The backlight compensation function provides compensation by increasing the brightness of the overall screen so that subjects being shot with a loss of dark detail due to backlight will have just the right brightness level.

Back Light Compensation

|  |          |
|--|----------|
| Port Driver Function(SW201_7) [C01_04CH.0-2] | [02H]ON  |
| Back Light Compensation Switch [C03_01EH.0]  | [00H]OFF |

|   |                            |
|---|----------------------------|
| Port Driver Function(SW201_8) [C01_054H.0-2]    | [02H]ON                    |
| Back Light Compensation Function [C03_01EH.1-2] | [01H]Auto Weighted Average |

#### Back Light Compensation Switch (BLCON)

When using the backlight and excessive front lighting compensation functions, set 1{h} to ON for the BLCON. When the user sets this parameter through the Control Software (DQUCtrl), please turn off the Port Driver.

Category: 03d

Start byte: 01EH.0

Condition: AEME = 0 (0h) (AE mode)

Setting: 0 (0h) to 1 (1h)

Selection:

0h: OFF

1h: ON

## Back Light Compensation Function (BLCMODE)

Selects the backlight compensation function mode. When the user sets this parameter through the Control Software (DQUctrl), please turn off the Port Driver.

Category: 03d

Start byte: 01EH.1-2

Condition: AEME = 0 (0h) (AE mode), Port Driver Function (SW201.8) = "ON"

Setting: 0 (0h) to 3 (3h)

Selection:

0h: Fixed weighted average

1h: Auto weighted average

2h: Reserved

3h: Reserved

Fixed Weighted Average

|   |   |   |
|---|---|---|
| 1 | 1 | 1 |
| 1 | 3 | 1 |
| 1 | 1 | 1 |

- 0window Weight [C03\_06FH]
- 1window Weight [C03\_070H]
- 2window Weight [C03\_071H]
- 3window Weight [C03\_072H]
- 4window Weight [C03\_073H]
- 5window Weight [C03\_074H]
- 6window Weight [C03\_075H]
- 7window Weight [C03\_076H]
- 8window Weight [C03\_077H]

## Frame Weighted Average (WEIGHT0- WEIGHT8)

The fixed weighting mode works when the position of the subject to be shot is already known. There are nine detector frames, and a weighting can be set separately for each. By increasing the weighting of the frame where the subject can be shot is present, the exposure is controlled so that the brightness is just right for the subject.

Category: 03d

- 0 Window: WEIGHT0 Start byte: 06FH.0-7
- 1 Window: WEIGHT1 Start byte: 070H.0-7
- 2 Window: WEIGHT2 Start byte: 071H.0-7
- 3 Window: WEIGHT3 Start byte: 072H.0-7
- 4 Window: WEIGHT4 Start byte: 073H.0-7
- 5 Window: WEIGHT5 Start byte: 074H.0-7
- 6 Window: WEIGHT6 Start byte: 075H.0-7
- 7 Window: WEIGHT7 Start byte: 076H.0-7
- 8 Window: WEIGHT8 Start byte: 077H0-7

Condition: AEME = 0 (0h) (AE mode), BLCON =1 (1h)

Setting: 0 (0h) to 255 (FFh)

Selection:

0[h] (minimum weighting) - FF[h] (maximum weighting)

Correlation between frames and weighting parameters

|          |          |          |
|----------|----------|----------|
| Window 0 | Window 1 | Window 2 |
| Window 3 | Window 4 | Window 5 |
| Window 6 | Window 7 | Window 8 |

AE Detector Frames

AED Frames Horizontal 1 [C03\_03EH.1-03FH.1] 128

AED Frames Horizontal 2 [C03\_03FH.2-040H.2] 256

AED Frames Vertical 1 [C03\_043H.2-044H.2] 82

AED Frames Vertical 2 [C03\_045H.0-046H.0] 164

## AED Frame Horizontal 1,2 (AEDWH1, AEDWH2)

AEDWH1 : AED Frame Horizontal 1

AEDWH2 : AED Frame Horizontal 2

|            | AEDWH1,   | AEDWH2  |
|------------|---|---|
| Outline    | Sets the horizontal positions of the AED frames                                       |   |
| Category   | 03 d  |   |
| Start byte | 03EH.1 to 03FH.1  | 03FH.2 to 040H.2  |
| Setting    | 0 (0h) to 480 (1E0h)<br>$1 \leq \text{AEDWH1} \leq$<br>Maximum horizontal<br>value -2 | 0 (0h) to 480 (1E0h)<br>$2 \leq \text{AEDWH2} \leq$<br>Maximum horizontal<br>value -1 |
| Selection  | This sets the horizontal positions of the AED frames                                  |   |

The maximum horizontal values differ depending on the CCD image sensor used.

## AED Frame Vertical 1,2 (AEDWV1, AEDWV2)

AEDWV1: AED Frame Vertical 1

AEDWV2: AED Frame Vertical 2

|            | AEDWV1,   | AEDWV2  |
|------------|---|---|
| Outline    | Sets the vertical positions of the AED frames                                       |   |
| Category   | 03 d  |   |
| Start byte | 043H.2 to 044H.2  | 045H.0 to 046H.0  |
| Setting    | 0 (0h) to 290 (122h)<br>$1 \leq \text{AEDWV1} \leq$<br>Maximum vertical<br>value -2 | 0 (0h) to 290 (122h)<br>$2 \leq \text{AEDWV2} \leq$<br>Maximum vertical<br>value -1 |
| Selection  | This sets the vertical positions of the AED frames                                  |   |

The maximum vertical values differ depending on the CCD image sensor used.

## AE Detector frame settings

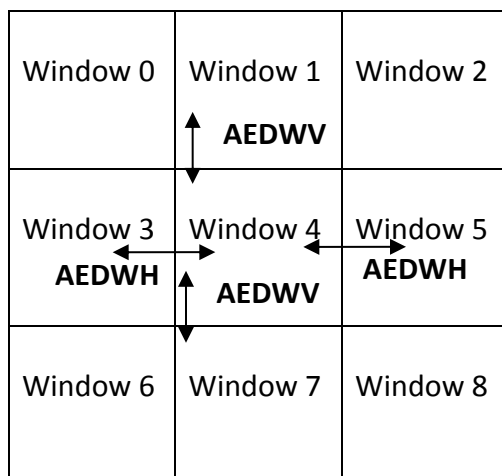

Set the parameters so that the following conditions are met.

$$AEDWH1 < AEDWH2$$

$$AEDWV1 < AEDWV2$$

Number of effective pixels per CCD device

|                                       | 760H NTSC | 760H PAL |
|---------------------------------------|-----------|----------|
| Number of effective horizontal pixels | 768       | 752      |
| Number of effective vertical pixels   | 492       | 580      |

AE detector frame setting range

|   | 760H NTSC | 760H PAL  |
|---|-----------|-----------|
| Minimum horizontal value<br>(minimum value of AEDWH1) | 1 (1h)    | 1(1h)     |
| Maximum horizontal value<br>(maximum value of AEDWH2) | 383(18Fh) | 375(177h) |
| Minimum vertical value<br>(minimum value of AEDWV1)   | 1(1h)     | 1(1h)     |
| Maximum vertical value<br>(maximum value of AEDWV2)   | 245(F5h)  | 289(121h) |

### Auto Weighting Mode

In the auto weighting mode, backlight compensation, which is not dependent on the position of the subject to be shot, can be implemented, and the mode works when there is a difference in brightness between the background and subject to be shot.

AE Detector Frames

Diagram labels: WH1, WV1, WH2, WV2

- AED Frames Horizontal 1 [C03\_03EH.1-03FH.1] = 128
- AED Frames Horizontal 2 [C03\_03FH.2-040H.2] = 256
- AED Frames Vertical 1 [C03\_043H.2-044H.2] = 82
- AED Frames Vertical 2 [C03\_045H.0-046H.0] = 164

## 7.3.6 White Balance

### AWB Mode(Auto White Balance Operation Mode (AWB))

Auto White Balance (AWB) is a function which compensates for deviations in the white color caused by changes in the color temperature of the light source to control the white balance gain within the chroma signal processing so that the colors are reproduced correctly. when user set this parameter through Control Software (DQUCtrl), please turn off the Port Driver

Category: 05 d

Start byte: 001H.0-3

Condition: -

Setting: 0 (0h) to 8 (8h), Port Driver Function (SW202.4) = "ON"

Selection:

- 0h: Auto trace white balance
- 1h: Full Pull IN
- 2h: Reserved
- 3h: Hold
- 4h: Reserved
- 5h: Reserved
- 6h: Reserved
- 7h: User setting
- 8h: Reserved

### **Auto Trace White Balance**

This function automatically tracks the changes in the color temperature, and adjusts the white balance. Pull-in control is exercised only when the color temperature is determined to be inside the pull-in frame.

### **Full Pull IN (Push to Set White Balance)**

This function adjusts the white balance regardless of the subject conditions.

Pull-in control is exercised at all times independently of the pull-in frame which was set by the pre-white balance adjustment. This mode works faster than ATW mode.



## Hold

In this mode, the colors are held using the gain values established immediately before control was set to the hold mode. A push-lock mode can be configured by using this function in combination with the Push mode. In this mode, operation is set to the hold mode after pull-in in the Push mode and the R and B gain values established at that point are written into the Flash ROM.

## User

In this mode, fixed gain values [WBUSRR](#) (R gain for the user mode), [WBUSRB](#) (B gain for the user mode) are referred.

## Manual White Balance (USER Mode)

### R Gain Of USER Mode (WBUSRR)

Sets the R gain for the manual (user) white balance

Category: 05 d

Start byte: 013H.0-014H.3

Condition: AWB = 7 (7h)

Setting: 0 (0h) to 256 (FFh)

### B Gain Of USER Mode (WBUSRB)

Sets the B gain for the manual (user) white balance

Category: 05 d

Start byte: 015H.0-016H.3

Condition: AWB = 7 (7h)

Setting: 0 (0h) to 4095 (FFFh)

## 7.3.7 ME

### Select AE/ME (AEME)

The AEME parameter is used to select auto exposure control (AE) or manual exposure control (ME).

Category: 03 d

Start byte: 001H.0

Condition: -

Setting: 0 (0h) to 1 (1h)

Selection:

0h: AE (Auto exposure)

1h: ME (Manual exposure)

### Select ME Mode (MEMODE)

Selects the manual exposure control mode.

AE mode has to be set as "Manual exposure (AEME = 1 (1h))" to activate this manual exposure control mode selection

Category: 04 d

Start byte: 001H.0

Condition: AEME = 1 (1h) (ME mode)

Setting: 0 (0h) to 1 (1h)

Selection:

0h: Shutter + AGC Manual

1h: SLOW Shutter + AGC Manual

## Manual Shutter Speed

Select the preset exposure time. When the user sets this parameter through the Control Software (DQUCtrl), please turn off the Port Driver.

Category: 04 d

Start byte: 001H.2-4

Condition: Port Driver Function(SW201\_2-4) OFF, Port Driver Function (SW201.2-4) = "ON"

Setting: 0 (0h) to 7(7h)

Selection:

0h: User Setting

1h: 1/125

2h: 1/250

3h: 1/500

4h: 1/1000

5h: 1/2000

6h: 1/4000

7h: 1/10000

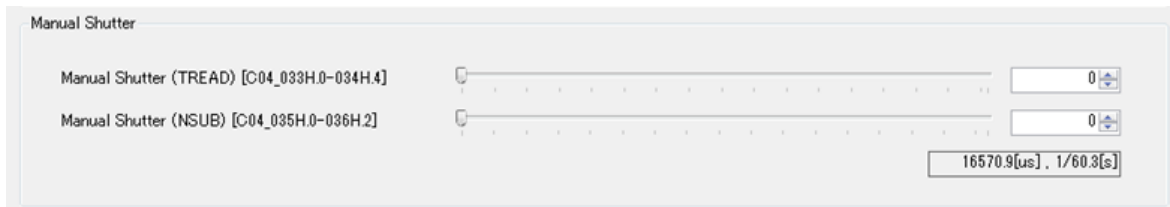

## Manual Shutter (TREAD)

Electronic shutter preset setting

Category: 04 d

Start byte: 033H.0-034H.4

Condition: MEMODE = 0 (0h)

Setting: 0 (0h) to 1151 (47Fh)

## Manual Shutter (NSUB)

Electronic shutter preset setting

Category: 04 d

Start byte: 035H.0-036H.2

Condition: MEMODE = 0 (0h)

Setting: 0 (0h) to 311 (137h)

## Electronic shutter exposure time calculation formula

nsub: NSUB tread: TREAD

The formulas for calculating the electronic shutter exposure times are listed in the table below. The electronic shutter exposure time extends from the SUB pulse applied last during one VD period to the read pulses.

"nsub" in the table below indicate the SUB pulse; "tread" indicate the read pulse.

The SUB pulse is set in HD increments, and the higher the value, the shorter the exposure time.

The read pulse is set in clock increments, and the higher the value, the longer the exposure time.

| CCD Type     |      | Exposure time  |
|--------------|------|--|
| 1/3"<br>1/2" | NTSC | $(261 - \text{nsub}) * 63.49\mu\text{s} + (\text{tread} * 69.84\text{ns})$<br>Setting range: nsub=0-261, tread=0-909<br>But when nsub = 0, then tread = 0<br>when nsub = 261, then tread = 143-909 |
|              | PAL  | $(311 - \text{nsub}) * 64.00\mu\text{s} + (\text{tread} * 70.48\text{ns})$<br>Setting range: nsub=0-311, tread=0-907<br>But when nsub = 0, then tread = 0<br>when nsub = 311, then tread=142-907   |

### #Example

1/100 sec exposure on NTSC : nsub = 104, tread = 459

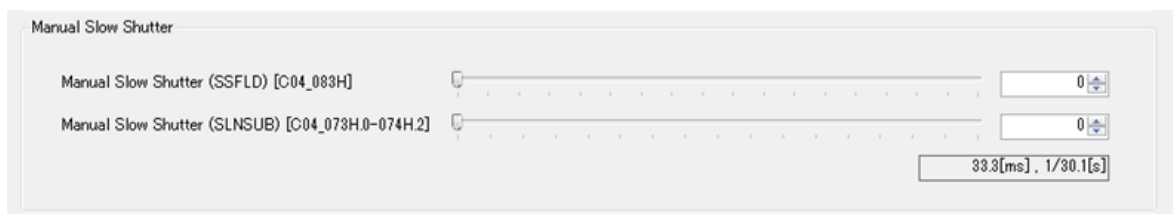

### Manual Slow Shutter (SSFLD)

Electronic shutter preset setting

Category: 04 d

Start byte: 083H.0-7

Condition: MEMODE = 1 (1h)

Setting: 0 (0h) to 255 (FFh)

Selection:

(N+1) x 2Field

## Manual Slow Shutter (SLNSUB)

Electronic shutter preset setting

Category: 04 d

Start byte: 073H.0-074H.2

Condition: MEMODE = 1 (1h)

Setting: 0 (0h) to 624 (270h)

Selection:

## Low-speed shutter exposure time calculation formulas

ssfld : SSFLD

nsub : SLNSUB

With the low-speed shutter settings, the formula used to calculate the exposure time differs from one CCD type to another. The higher the "nsub" value, the shorter the exposure time in HD increments.

Furthermore, the higher the "ssfld" value, the longer the exposure time in 2-field increments.

| CCD Type     |      | Exposure time  |
|--------------|------|--|
| 1/3"<br>1/2" | NTSC | $(524 - nsub) * 63.49\mu s + (((ssfld + 1) * 2) - 2) * 16,634\mu s$<br>Setting range: nsub=0-524, ssfld=0-255<br>But when ssfld=0, setting nsub=524 is prohibited. |
|              | PAL  | $(624 - nsub) * 64.00\mu s + (((ssfld + 1) * 2) - 2) * 19,968\mu s$<br>Setting range: nsub=0-624, ssfld=0-255<br>But when ssfld=0, setting nsub=624 is prohibited. |

### #Example

1/2 sec exposure on NTSC : nsub = 508, ssfld = 15 => 500ms



## Manual AFE Gain (APGA)

VGA (Variable Gain Amp) preset setting for AFE  
 Selects the ME control mode. Work on AEME =1.  
 AFE gain (analog gain)

Category: 04 d

Start byte: 003H.0-004H.2

Condition: AEME = 1 (1h) (ME mode)

Setting: 0 (0h) to 1580 (62Ch)

Selection:

$$\text{Gain value [dB]} = (\text{APGA parameter value} * 0.0342) - 6$$

AFE VGA (Variable gain amp) value calculation formula

The formula for calculating the VGA value of this camera is shown below.

<Parameters supported>

APGA parameters : APGA

$$\text{Gain value [dB]} = (\text{APGA parameter value} * 0.0342) - 6$$

The setting ranges of the APGA parameters (APGA) differ depending on the DPGA value as shown in "APGA parameter setting range" as below.

The DPGA value is determined solely by the saturation signal volume of the CCD image sensor used.

APGA parameter setting range

| DPGA<br>(CAT13_Byte42_bit3-4) | APGA<br>Setting range | Gain range supported |
|-------------------------------|-----------------------|----------------------|
| 0                             | 0[h] - 524[h]         | -6[dB] - 57[dB]      |
| 1                             | 58[h] - 57C[h]        | -3[dB] - 42[dB]      |
| 2                             | B0[h] - 5D4[h]        | 0[dB] - 45[dB]       |
| 3                             | 108[h] - 62C[h]       | 3[dB] - 48[dB]       |

Correlation between APGA setting values and gain values

The figure below shows the correlation between the parameter setting values and the gain values

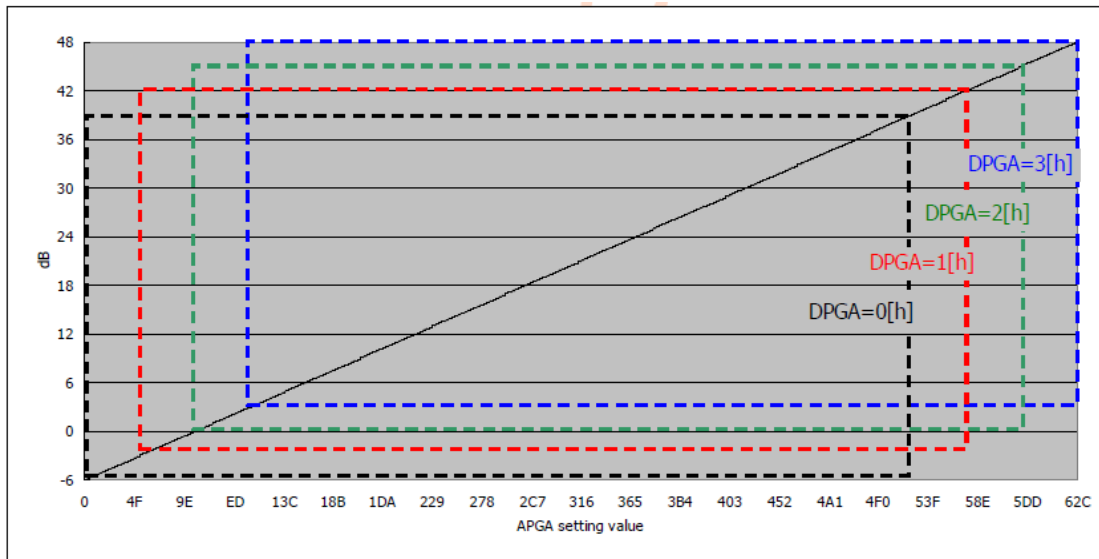

### Manual DSP Gain (DPGAL)

Preset setting for long-time exposure side PGA (programmable gain amp) of DSP  
It means same as digital gain.

Category: 04 d

Start byte: 13 H.0- 14 H.2

Condition: MEMODE = 0, 1 (0,1h)

Setting: 0 (0h) to 2047 (7FFh)

Selection:

DSP PGA Gain value [dB] =  $20 * \log_{10} (\text{DPGAL}0 / 256)$  [dB]

The parameter setting range is 0[h] to 7FF[h]

### 7.3.8 Aperture

This function compensates the edges to increase the image resolution as it appears. The edge enhancement level is adjusted by setting the gain. System enables the horizontal and vertical aperture compensation to be set separately. VH aperture compensation for adjusting the overall aperture compensation gain is also available. To increase the resolution as it appears and enhance the edges, select high settings for the gain values. However, bear in mind that ringing will become more noticeable when the gain values are set too high.

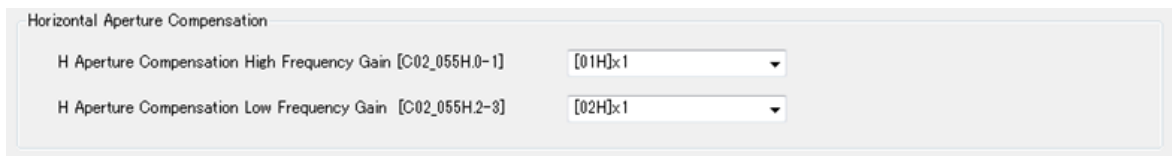

#### H Aperture Compensation High Frequency Gain(HAPGH)

Sets the high-range gain for horizontal aperture compensation.

Category: 02 d

Start byte: 055 H.0- 1

Condition: -

Setting: 0 (0h) to 3(3h)

Selection:

0h : x0

1h : x1

2h : x2

3h : x4

#### H Aperture Compensation Low Frequency Gain(HAPGL)

Sets the low-range gain for horizontal aperture compensation.

Category: 02 d

Start byte: 055 H.2- 3

Condition: -

Setting: 0 (0h) to 3(3h)

Selection:

0h : x0

1h : x0.5

2h : x1

3h : x2

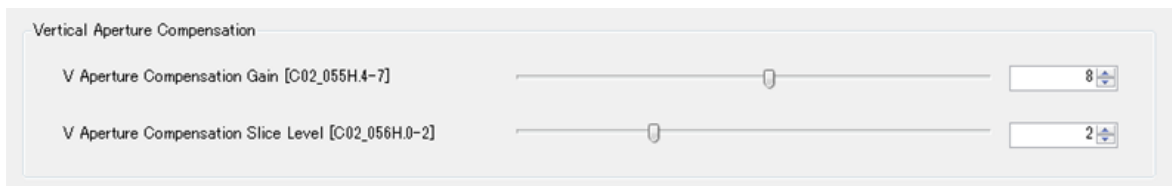



### V Aperture Compensation Gain(VAPG)

Sets the vertical aperture compensation gain.

Category: 02 d

Start byte: 055 H.4- 7

Condition: -

Setting: 0 (0h) to 15(Fh) (x0 to x1)

### V Aperture Compensation Slice Level(VAPSL)

Sets the slice level for the vertical aperture compensation.

Category: 02 d

Start byte: 056 H.0- 2

Condition: -

Setting: 0 (0h) to 7(7h) (slice level 0 - slice level max.)

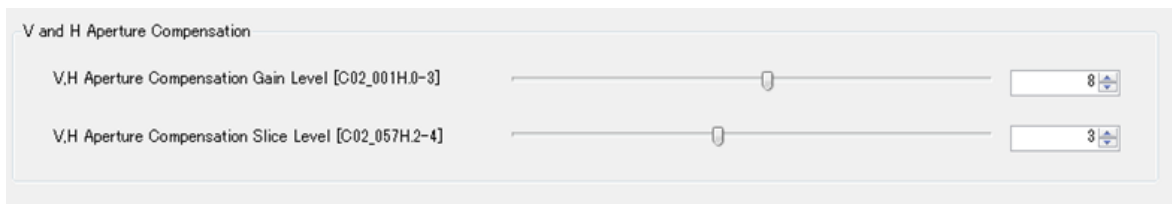

### V,H Aperture Compensation Gain Level(VHAPG)

Sets the gain level after adding the V and H aperture compensation values.

Category: 02 d

Start byte: 001 H.0- 3

Condition: -

Setting: 0 (0h) to 15(Fh) (x0 to x2)

### V,H Aperture Compensation Slice Level(VHAPSL)

Sets the slice level after VH aperture compensation.

Category: 02 d

Start byte: 057 H.2- 4

Condition: -

Setting: 0 (0h) to 7(7h) (slice level 0 - slice level max.)

## 7.3.9 Other

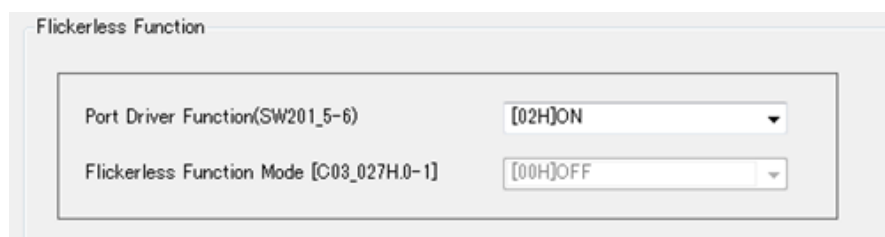

### Flickerless Function

Flicker occurs across the entire screen when subjects have been shot under conditions where the flashing periods for fluorescent lighting differ from the electronic shutter exposure times. This camera has two modes to deal with flicker: fixed shutter mode for fixing the electronic shutter value to the flashing period of the flicker, and the gain modulation mode for modulating the PGA value to the flashing period of the flicker.

### Flickerless Function Mode(FLCMODE)

Selects the flicker-less mode for the AE and WDR long-time exposure side. When the user sets this parameter through the Control Software (DQUctrl), please turn off the Port Driver.

Category: 03 d

Start byte: 027 H.0- 1

Condition: AEME =0[h], Port Driver Function (SW201.5-6) = "ON"

Setting: 0 (0h) to 2(2h)

Selection:

0h : OFF

1h : Fixed shutter mode

2h : Gain modulation mode

### **Shutter Speed Fixed**

In this mode, the electronic shutter speed is fixed to 1/100 (NTSC) or 1/120 (PAL) of the flashing period of the fluorescent lighting to minimize the flicker. In addition, if the 2 [h] fixed shutter mode has been selected as the AEMODE setting, the AE fixed shutter value takes precedence.

### **PGA Gain Control**

The gain modulation mode makes use of the fact that the flashing of the flicker changes cyclically to control the digital gain inside the DSP to minimize the flicker.

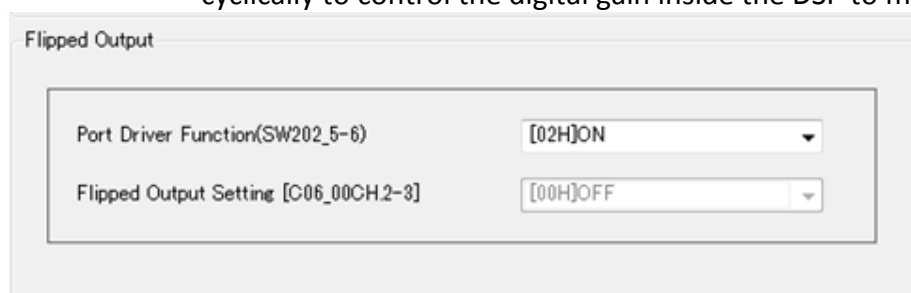

## Flipped Output Setting(MCOFLIPA)

Sets the analog output flip functions. When the user sets this parameter through the Control Software (DQUCtrl), please turn off the Port Driver.

Category: 06 d

Start byte: 00C H.2- 3

Condition: Port Driver Function (SW202.5-6) = "ON"

Setting: 0 (0h) to 3(3h)

Selection:

- 0h: OFF (no flipping)
- 1h: Top/bottom reversal
- 2h: Left/right reversal
- 3h: Rotation by 180 degrees

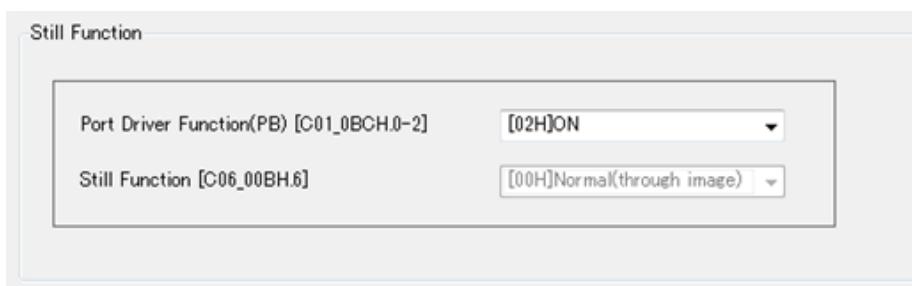

## Still Function(MCOMODEA)

The still function freezes the frames of moving images which are being shot.

The image applying when the MCOMODEA parameter was set to 1[h] is freeze-framed.

The electronic zoom or flip function can be applied to freeze-framed images. When the user sets this parameter through the Control Software, please turn off the Port Driver.

Category: 06 d

Start byte: 00B H.6

Condition: Port Driver Function (Category 01d,StartVyte 0BCH.0-2) = "ON"

Setting: 0 (0h) to 1(1h)

Selection:

- 0h: Through images
- 1h: Still images (freeze-frame)

## Revisions

| Rev. | Date       | Changes                                | Editor |
|------|------------|--|--------|
| .04  | 12/05/2013 | Created New Document                   | RM     |
| 1.01 | 12/30/2013 | Updated to STJ Version<br>2/12/14 - GE | RM     |
| 1.03 | 4/9/2014   | Updated to Current Version             | RM     |

**Sensor Technologies America, Inc.**  
1345 Valwood Pkwy, Suite 320  
Carrollton, TX 75006  
TEL:(972)-481-9223  
FAX: (972)-481-9209  
[www.SentechAmerica.com](http://www.SentechAmerica.com)